

NORTH ELEVATION FRONT SIGN

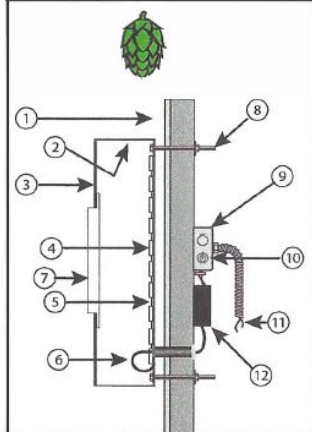

LED-ILLUMINATED REVERSE PAN CHANNEL LETTER

1. STOREFRONT FASCIA
2. 3 INCH .040 ALUMINUM RETURNS
3. FACE .090 ALUMINUM
4. LED ILLUMINATION WHITE
5. CLEAR LEXAN BACK
6. LOW-VOLTAGE WIRE
7. 1/2" WHITE PUSHTHRU ACRYLIC
8. FASTENER WITH 1" STAND-OFF
9. STANDARD ELECTRICAL JUNCTION BOX
10. DISCONNECT SWITCH
11. PRIMARY ELECTRIC SUPPLY INSIDE FLEXIBLE CONDUIT
12. UL APPROVED LED DRIVER

ALL COMPONENTS TO BEAR U.L. LABEL AND ARE 120 VOLTS UNLESS OTHERWISE INDICATED

PERMIT - ELECTRICAL INFORMATION

VOLTS REQ'D: 120 TOTAL AMPS: 3
 CUSTOMER TO PROVIDE REQUIRED ELECTRICAL TO SIGN LOCATION
 CIRCUITS REQUIRED: 1
 WIRING AS PER U.L. LABEL: X
 ALWAYS OPERATE LED SIGNS WITH A TIMER OR PHOTO CELL

This sign is intended to be installed in accordance with the requirements of article 600 of the national electrical code and/or other applicable local codes. This includes proper grounding and bonding of the sign.

The location of the disconnect switch after installation shall comply with Article 600.6(A)(1) of the National Electrical Code.
 E354615 U.L. LISTED

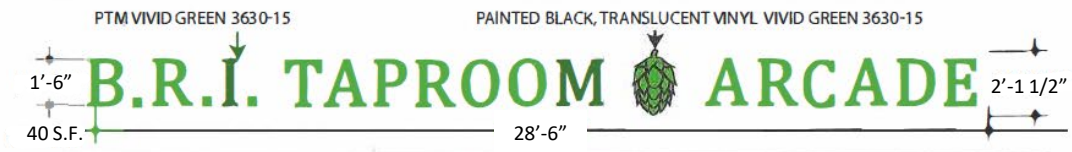

42' FRONTAGE

Please carefully check this layout. Check all spelling and be sure all colors and proportions are to your specifications. If order is changed or cancelled after approval, 1 Stop Signs reserves the right to charge for work and/or material already ordered.

213 & 215 W Main St
 Mesa, AZ 85201

LANDLORD APPROVAL: *Bongill* DATE: *Aug 17, 2021*
 CUSTOMER APPROVAL: _____ DATE: _____

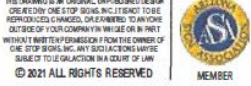

INTERNATIONAL SIGN ASSOCIATION



Customer: BRI Tap - Arcade
 E-mail: _____
 Project: Signage
 Drawing: BRI Tap - Arcade.ai
 Make Changes: _____
 Approved: _____
 Date: (07/19/2021, 09:48 am)

B.R.I. TAPROOM ARCADE

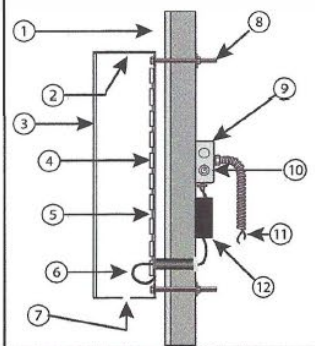

LED-ILLUMINATED REVERSE PAN CHANNEL LETTER

1. STOREFRONT FASCIA
2. 3 INCH .040 ALUMINUM RETURNS
3. FACE .090 ALUMINUM
4. LED ILLUMINATION WHITE
5. CLEAR LEXAN BACK
6. LOW-VOLTAGE WIRE
7. 1/4 WEEP HOLES
8. FASTENER WITH 1" STAND-OFF
9. STANDARD ELECTRICAL JUNCTION BOX
10. DISCONNECT SWITCH
11. PRIMARY ELECTRIC SUPPLY INSIDE FLEXIBLE CONDUIT
12. UL APPROVED LED DRIVER

ALL COMPONENTS TO BEAR U.L. LABEL AND ARE 120 VOLTS UNLESS OTHERWISE INDICATED



PERMIT - ELECTRICAL INFORMATION

VOLTS REQ'D: 120 TOTAL AMPS: 3
 CUSTOMER TO PROVIDE REQUIRED ELECTRICAL TO SIGN LOCATION
 CIRCUITS REQUIRED: 1
 WIRING AS PER U.L. LABEL: X
 ALWAYS OPERATE LED SIGNS WITH A TIMER OR PHOTO CELL

This sign is intended to be installed in accordance with the requirements of article 600 of the national electrical code and/or other applicable local codes. This includes proper grounding and bonding of the sign.

The location of the disconnect switch after installation shall comply with Article 600.6(A)(1) of the National Electrical Code.
 E354615 U.L. LISTED

NORTH ELEVATION BLADE SIGN

<p>NIGHT VIEW</p> 	<p>10" DEEP ALUMINUM CABINET, FACE ROUTED OUT DOUBLE SIDED, PAINTED BLACK AND PTM VIVID GREEN 3630-15</p>	<p>1/2" PUSH THRU WHITE ACRYLIC TRANSLUCENT VINYL VIVID GREEN 3630-15</p>	<p>GREEN NEON</p> 
---	---	---	---



THRU BOLT AND SECURE ON BACK SIDE OF WALL. MOUNT 1/2" PLATE TO BACK SIDE OF WALL.

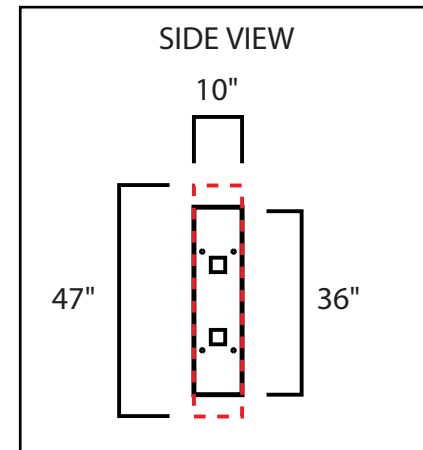

PERMIT - ELECTRICAL INFORMATION

VOLTS REQ'D: 120 TOTAL AMPS: 3
 CUSTOMER TO PROVIDE REQUIRED ELECTRICAL TO SIGN LOCATION
 CIRCUITS REQUIRED: 1
 WIRING AS PER U.L. LABEL: X
 ALWAYS OPERATE LED SIGNS WITH A TIMER OR PHOTO CELL

This sign is intended to be installed in accordance with the requirements of article 600 of the national electrical code and/or other applicable local codes. This includes proper grounding and bonding of the sign.

The location of the disconnect switch after installation shall comply with Article 600.6(A)(1) of the National Electrical Code.

E354615 U.L. LISTED

Please carefully check this layout. Check all spelling and be sure all colors and proportions are to your specifications. If order is changed or cancelled after approval, 1 Stop Signs reserves the right to charge for work and/or material already ordered.

213 & 215 W Main St.
Mesa, AZ 85201

LANDLORD APPROVAL _____ DATE _____
 CUSTOMER APPROVAL _____ DATE _____

Customer: BRI Tap - Arcade
 E-mail:
 Project: Signage
 Drawing: BRI Tap - Arcade.ai
 Make Changes:
 Approved:
 Date: (07/19/2021, 09:48 am)

THIS DRAWING IS AN ORIGINAL, UNPUBLISHED DESIGN CREATED BY ONE STOP SIGNS, INC. IT IS NOT TO BE REPRODUCED, CHANGED, OR EXHIBITED TO ANYONE OUTSIDE OF YOUR COMPANY IN WHOLE OR IN PART WITHOUT WRITTEN PERMISSION FROM THE OWNER OF ONE STOP SIGNS, INC. ANY SUCH ACTIONS MAY BE SUBJECT TO LEGAL ACTION IN A COURT OF LAW
 © 2021 ALL RIGHTS RESERVED



NORTH ELEVATION BLADE SIGN

3'-3 1/2"



4'-0"



14'-0"
AFF

213 & 215 W Main St.
Mesa, AZ 85201

Please carefully check this layout. Check all spelling and be sure all colors and proportions are to your specifications. If order is changed or cancelled after approval, 1 Stop Signs reserves the right to charge for work and/or material already ordered.

LANDLORD APPROVAL _____ DATE _____
 CUSTOMER APPROVAL _____ DATE _____

Customer: BRI Tap - Arcade
 E-mail:
 Project: Signage
 Drawing: BRI Tap - Arcade.ai
 Make Changes:
 Approved:
 Date: (07/19/2021, 09:48 am)

THIS DRAWING IS AN ORIGINAL, UNPUBLISHED DESIGN CREATED BY ONE STOP SIGNS, INC. IT IS NOT TO BE REPRODUCED, CHANGED, OR EXHIBITED TO ANYONE OUTSIDE OF YOUR COMPANY IN WHOLE OR IN PART WITHOUT WRITTEN PERMISSION FROM THE OWNER OF ONE STOP SIGNS, INC. ANY SUCH ACTIONS MAY BE SUBJECT TO LEGAL ACTION IN A COURT OF LAW
 © 2021 ALL RIGHTS RESERVED



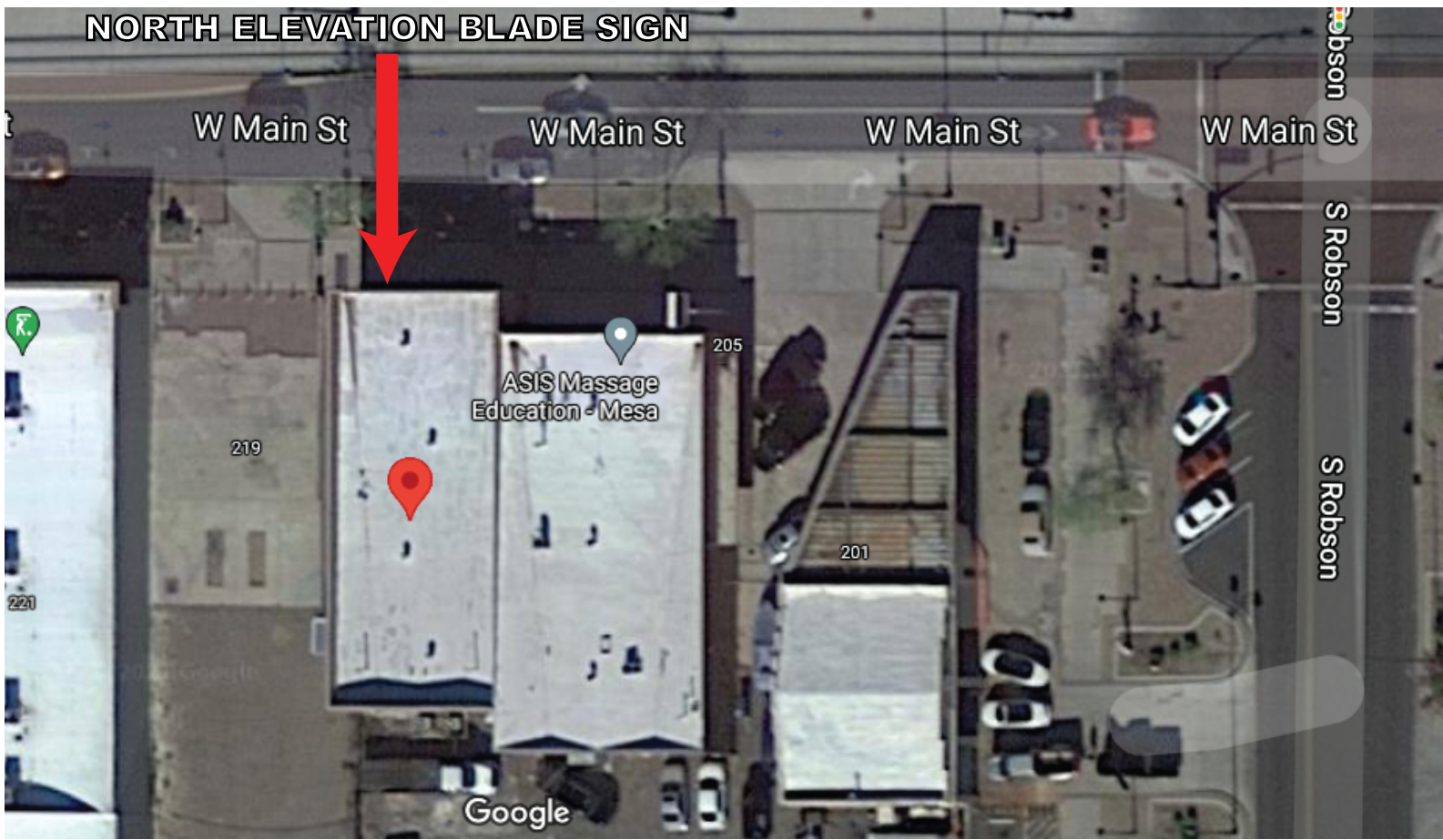
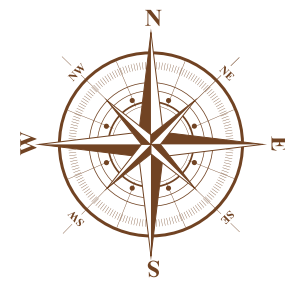

Please carefully check this layout. Check all spelling and be sure all colors and proportions are to your specifications. If order is changed or cancelled after approval, 1 Stop Signs reserves the right to charge for work and/or material already ordered.

LANDLORD APPROVAL _____ DATE _____
 CUSTOMER APPROVAL _____ DATE _____

Customer: BRI Tap - Arcade
 E-mail: _____
 Project: Signage
 Drawing: BRI Tap - Arcade.ai
 Make Changes: _____
 Approved: _____
 Date: (07/19/2021, 09:48 am)

213 & 215 W Main St.
 Mesa, AZ 85201

THIS DRAWING IS AN ORIGINAL, UNPUBLISHED DESIGN CREATED BY ONE STOP SIGNS, INC. IT IS NOT TO BE REPRODUCED, CHANGED, OR EXHIBITED TO ANYONE OUTSIDE OF YOUR COMPANY IN WHOLE OR IN PART WITHOUT WRITTEN PERMISSION FROM THE OWNER OF ONE STOP SIGNS, INC. ANY SUCH ACTIONS MAY BE SUBJECT TO LEGAL ACTION IN A COURT OF LAW
 © 2021 ALL RIGHTS RESERVED



INTERNATIONAL
 SIGN ASSOCIATION

