

REVISIONS

CED. ASSOCIATES LLC
 ARCHITECTURE
 AND INTERIOR DESIGN

1008 W. 70TH STREET, MESA, AZ 85209
 PHONE: 480-434-1118
 EMAIL: ced@cedassociates.com

OUTLAW TRUCKING
 54TH STREET BUSINESS PARK
 5305 EAST MAIN STREET
 MESA, AZ 85205

THIS DRAWING AND DATA CONTAINED HEREON ARE THE PROPERTY OF CED ASSOCIATES LLC AND MAY NOT BE USED, REPRODUCED, COPIED OR TRANSMITTED, WITHOUT THE EXPRESS WRITTEN CONSENT OF THE PROPRIETOR AND/OR COMPANY REPRESENTATIVE. NO SMALL ANY DATA OR INFORMATION CONTAINED HEREON BE USED IN PART OR IN FULL FOR ANY OTHER PURPOSE THAN THAT DESCRIBED WITHIN THESE DOCUMENTS.

REGISTERED ARCHITECT
 13202 DANIEL CHRISTENSEN
 07-23
 ARIZONA, U.S.A.
 30 JUN 2026

ELEVATIONS
 ARCHITECTURAL DRAWINGS

BY: MOW DATE:

A-8

FILE NO.
 15-CM-001

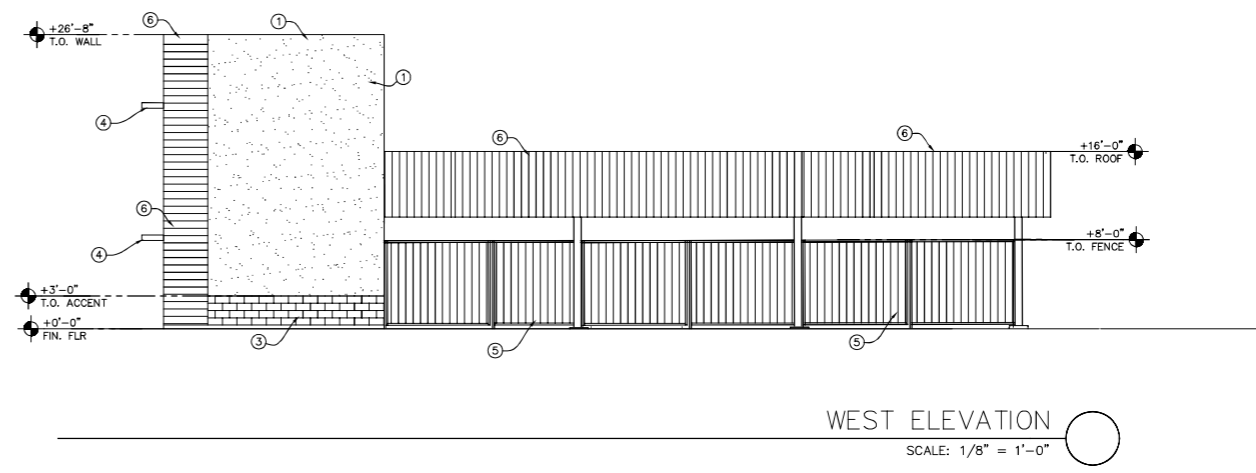
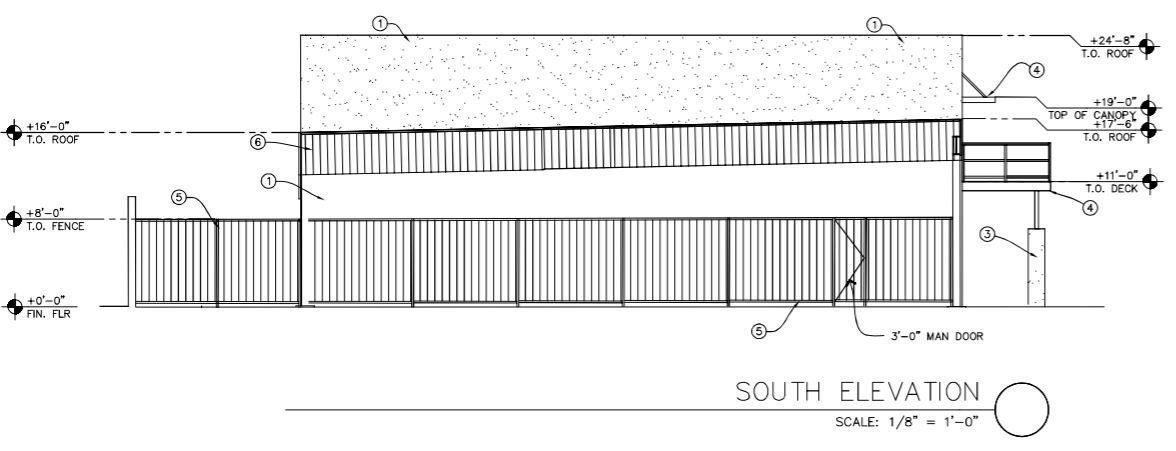
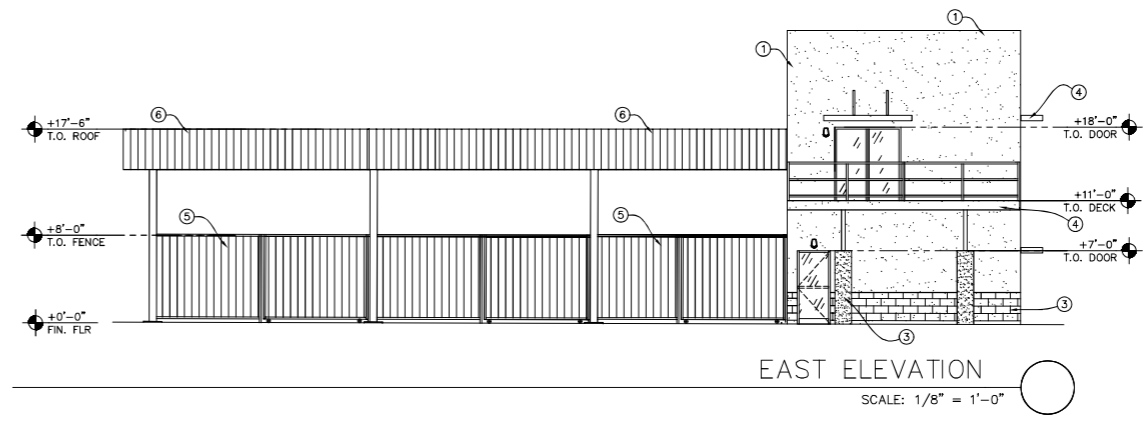
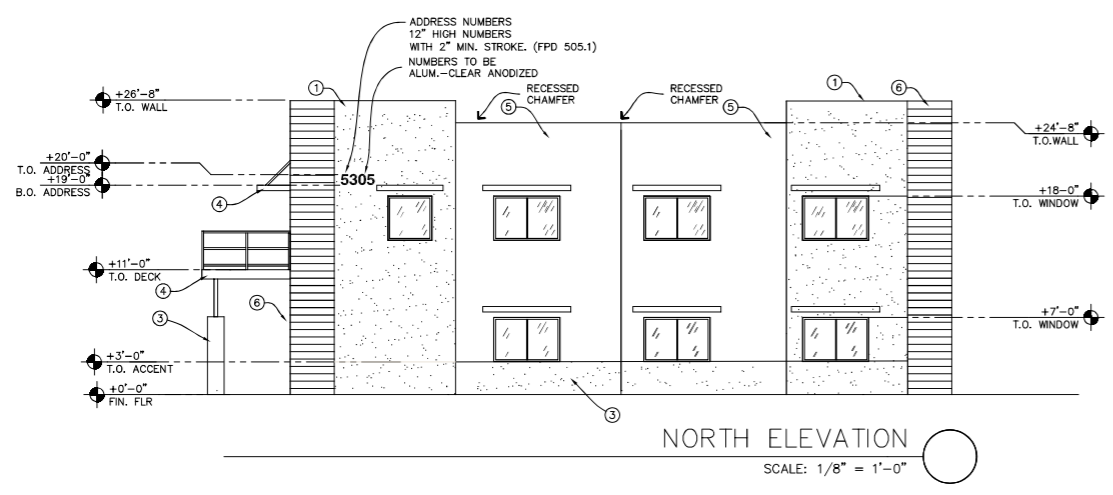

COLOR SCHEDULE:

① BUILDING BASE COLOR: BEHR: DARK MIST 8330-3	⑤ PRECAST CONCRETE TILT-PANEL
② HORIZONTAL ACCENT COLOR: BEHR: MOUNTAIN ROSE 7808-6	⑥ PRECAST CONCRETE TILT-PANEL
③ HORIZONTAL ACCENT COLOR: BEHR: MOUNTAIN ROSE 7808-6	⑦ PRECAST CONCRETE TILT-PANEL
④ METAL CANOPY: MBCR: BURNING SLATE SIGNATURE 200	⑧ METAL CANOPY
⑤ SECONDARY ACCENT #1: BEHR: DARK RUFFLE PPG-11	⑨ PRECAST CONCRETE TILT-PANEL
⑥ METAL ACCENT: MBCR: BURNING SLATE SIGNATURE 200	⑩ METAL ACCENT PANEL

REVISIONS

C.E.W. ASSOCIATES LLC
 Architecture, design
 928 S. STATE ST. SUITE 100, MESA, AZ 85208
 PHONE: 480-544-1818
 EMAIL: cewassociates@tuboo.com

OUTLAW TRUCKING
 54TH STREET BUSINESS PARK
 5305 EAST MAIN STREET
 MESA, AZ 85205

THIS DRAWING AND DATA CONTAINED HEREON ARE THE PROPERTY OF C.E.W. ASSOCIATES LLC AND MAY NOT BE USED, REPRODUCED, COPIED OR TRANSMITTED, WITHOUT THE EXPRESS WRITTEN CONSENT OF THE PROPRIETOR AND/OR COMPANY REPRESENTATIVE. WE SHALL HAVE NO LIABILITY IN PART OR IN FULL FOR ANY OTHER PURPOSE THAN THAT SPECIFIED WITHIN THESE DOCUMENTS.

REGISTERED ARCHITECT
 13202
 DANA
 CHRISTENSEN
 07-23
 STATE OF ARIZONA, U.S.A.
 30 JUNE 2026

COLORED ELEVATIONS
 ARCHITECTURAL DRAWINGS

BY: MOW DATE:

A-9

FILE NO.
 15-CM-001

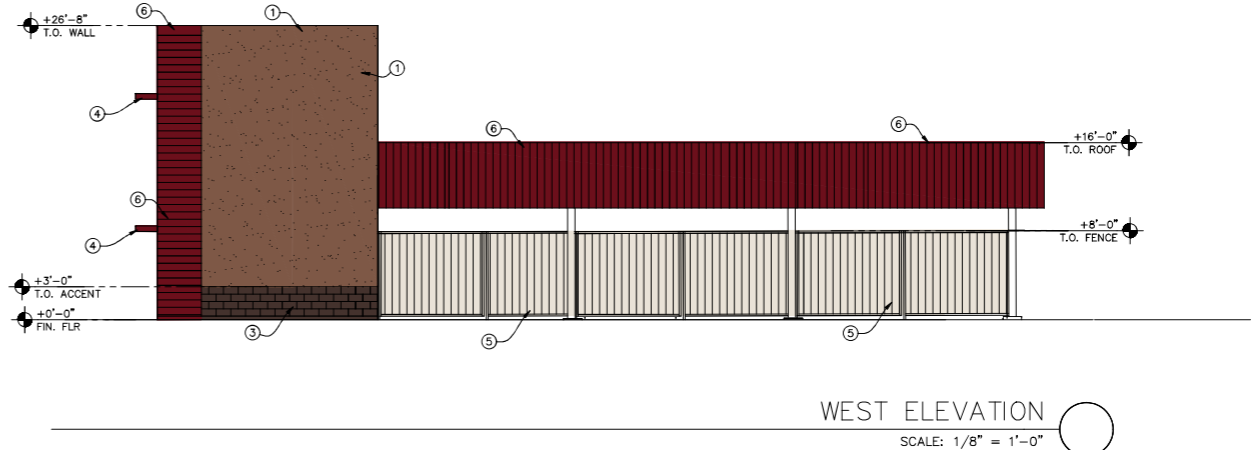
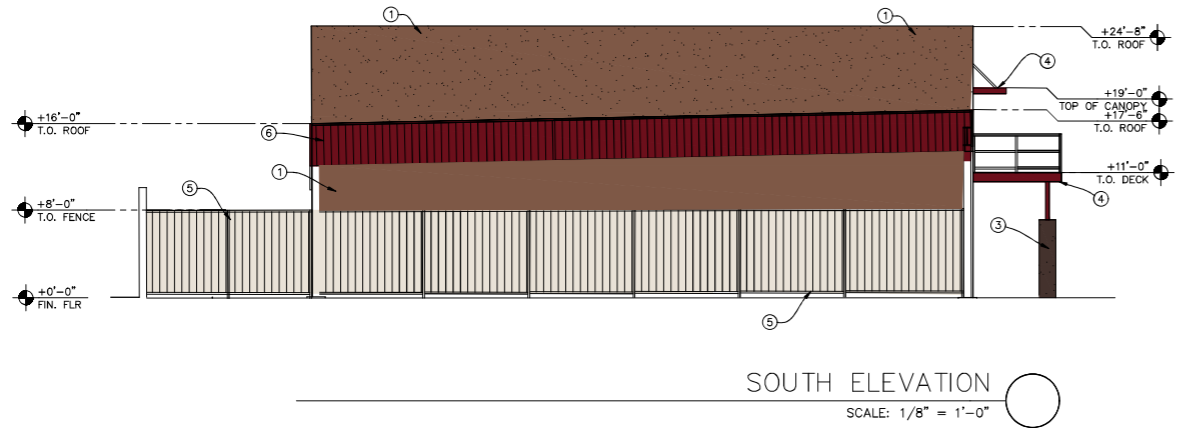
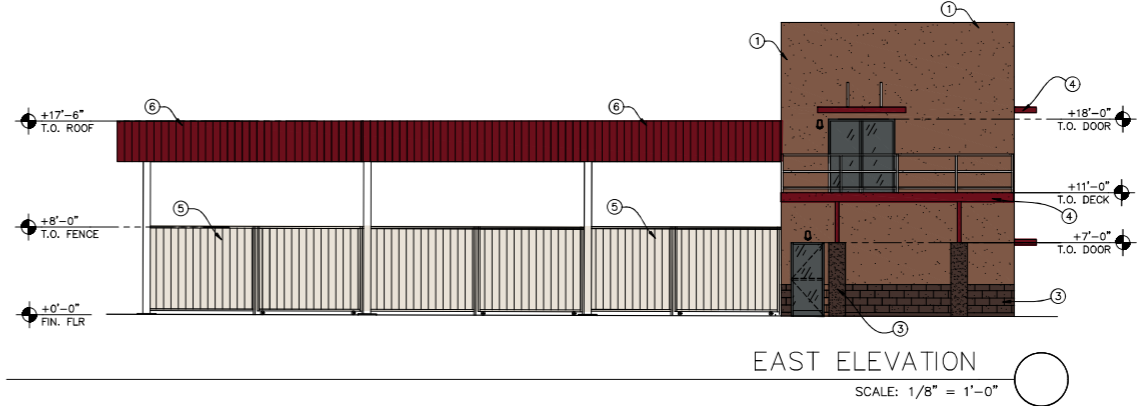
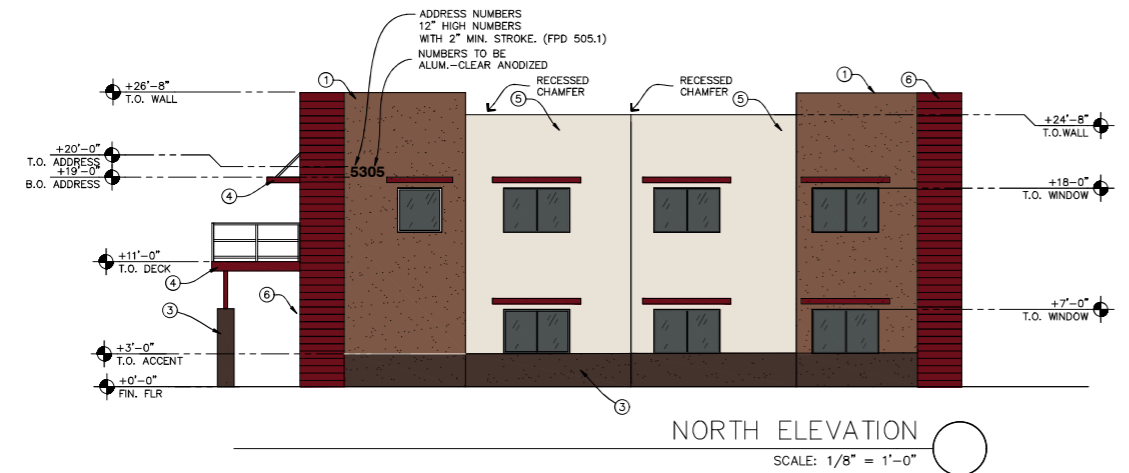

COLOR SCHEDULE:

① BUILDING BASE COLOR: BEHR: UNANIK TRAIL K330-3	⑤ PRECAST CONCRETE TILT-PANEL
② VERTICAL ACCENT COLOR: BEHR: MOUNTAIN ROSE 7008-6	⑥ PRECAST CONCRETE TILT-PANEL
③ HORIZONTAL ACCENT COLOR: BEHR: MOUNTAIN ROSE 7008-6	⑦ PRECAST CONCRETE TILT-PANEL
④ METAL CANOPY: MCC: BURNING SLATE SIGNATURE 200	⑧ METAL CANOPY
⑤ SECONDARY ACCENT: BEHR: DARK RUFFLE PP05-19	⑨ PRECAST CONCRETE TILT-PANEL
⑥ METAL ACCENT: MCC: BURNING SLATE SIGNATURE 200	⑩ METAL ACCENT PANEL

REVISIONS

CELLO ASSOCIATES LLC
 ARCHITECTURE, DESIGN
 402 S. 77TH ST. MESA, AZ 85209
 PHONE: (480) 434-1018
 EMAIL: celloassociates@cello.com

OUTLAW TRUCKING
54TH STREET BUSINESS PARK
5305 EAST MAIN STREET
MESA, AZ 85205

THIS DRAWING AND DATA CONTAINED HEREON ARE THE PROPERTY OF CELLO ASSOCIATES, L.L.C. AND MAY NOT BE USED, REPRODUCED, COPIED OR TRANSMITTED, WITHOUT THE EXPRESS WRITTEN CONSENT OF THE PROPRIETOR AND/OR COMPANY REPRESENTATIVE. NO PART OF THIS DRAWING OR INFORMATION CONTAINED HEREON BE USED IN PART OR IN FULL FOR ANY OTHER PURPOSE THAN THAT DESCRIBED WITHIN THESE DOCUMENTS.

REGISTERED ARCHITECT
 13202
 DAN CHRISTENSEN
 1-07-23
 MESA, ARIZONA, U.S.A.
 30 JUNE 2026

COLORED ELEVATIONS
 ARCHITECTURAL DRAWINGS

BY: MOW DATE:

A-9

FILE NO.
 15-CM-001

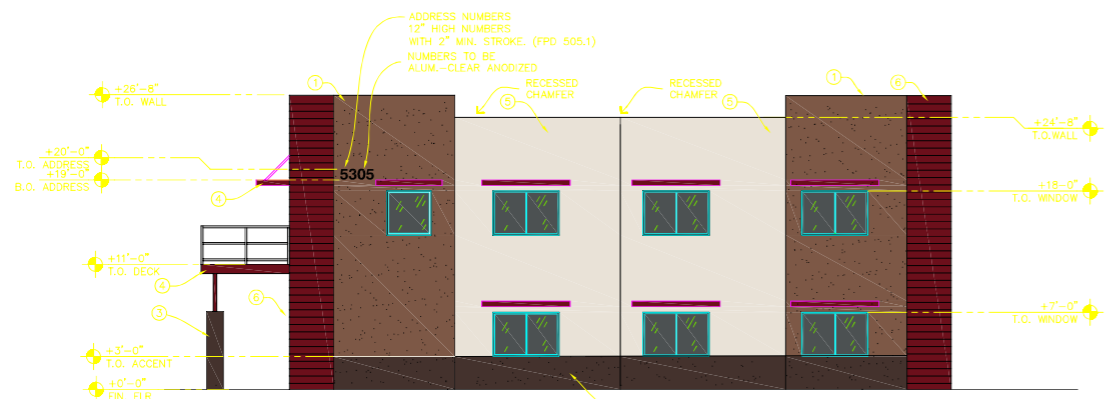

NORTH ELEVATION
 SCALE: 1/8" = 1'-0"

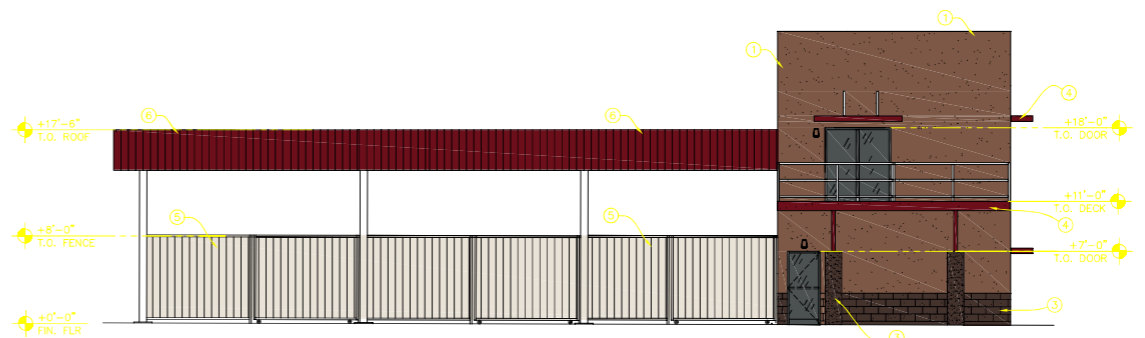

EAST ELEVATION
 SCALE: 1/8" = 1'-0"

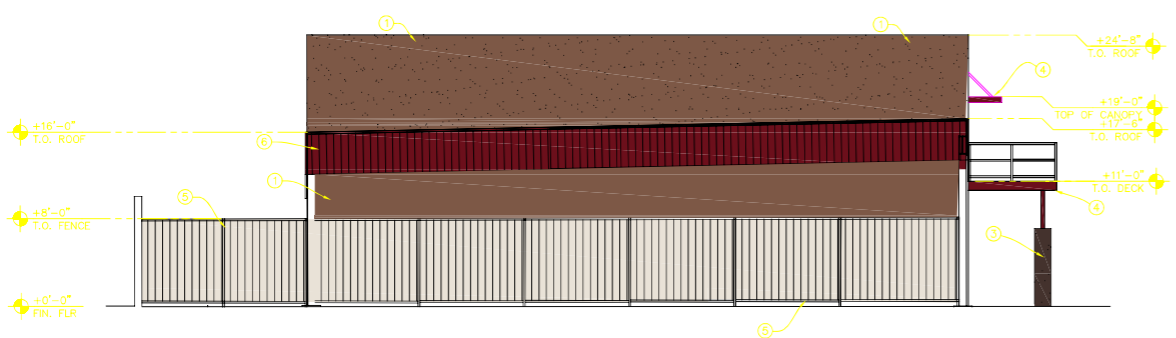

SOUTH ELEVATION
 SCALE: 1/8" = 1'-0"

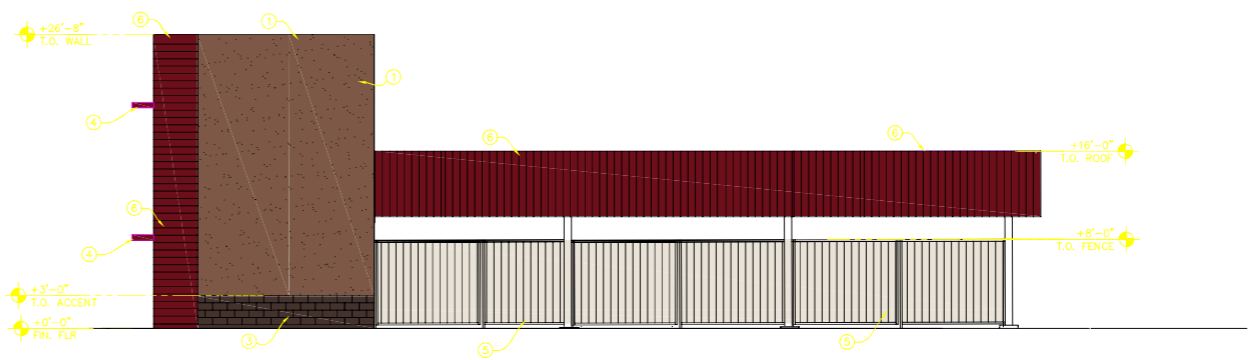

WEST ELEVATION
 SCALE: 1/8" = 1'-0"

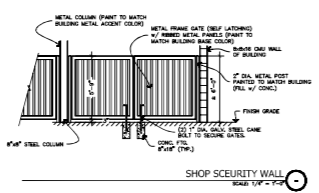

COLOR SCHEDULE:







① BUILDING BASE COLOR: BECR: LONKAWY TRAIL N33G-3	PRECAST CONCRETE TILT-PANEL
② VERTICAL ACCENT COLOR: BECR: MOUNTAIN RIDGE 782B-6	PRECAST CONCRETE TILT-PANEL
③ HORIZONTAL ACCENT COLOR: BECR: MOUNTAIN RIDGE 782B-6	PRECAST CONCRETE TILT-PANEL
④ METAL CANOPY: MCR: BURNING SLATE SIGNATURE 200	METAL CANOPY
⑤ SECONDARY ACCENT #1: BECR: DARK RUFFLE PFG-19	PRECAST CONCRETE TILT-PANEL
⑥ METAL ACCENT: BURNING SLATE SIGNATURE 200	METAL ACCENT PANEL



BUILDING SECTION SHOWING INTERIOR SOUTH ELEVATION

SCALE: 3/16" = 1'-0"

COLOR SCHEDULE:

①	BUILDING BASE COLOR: BEHR: UNMARK TRAIL N330-3		
②	VERTICAL ACCENT COLOR: BEHR: MOUNTAIN RIDGE 780B-6		
③	WAINSCOTT ACCENT COLOR: BEHR: MOUNTAIN RIDGE 780B-6		
④	METAL CANOPYs MBCI: BURNING SLATE SIGNATURE 200		METAL CANOPY
⑤	SECONDARY ACCENT #1 BEHR: DARK RUFFLE PPUS-19		
⑥	METAL ACCENT MBCI: BURNING SLATE SIGNATURE 200		METAL ACCENT PANEL