

NUVISION CREDIT UNION

LONGBOW BRANCH

DATE :

VERSION :

APPROVED BY:

[Signature Line]

SIGNATURE

DATE



6950 West Morelos Place, Chandler, AZ 85226
P 602.264.7263 | www.dbsi-inc.com



WEDGE1 LED

Architectural Wall Sconce



Catalog Number

Notes

Type

Hit the Tab key or mouse over the page to see all interactive elements.

Specifications

Depth (D1): 5.5"
Depth (D2): 1.5"
Height: 8"
Width: 9"
Weight: 9 lbs
 (without options)

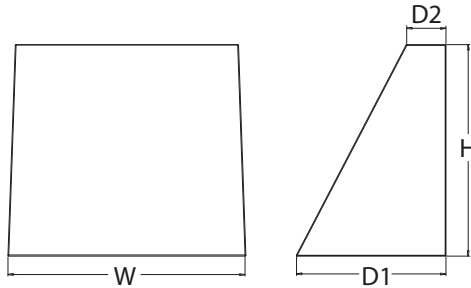

Introduction

The WEDGE LED family is designed to meet specifier's every wall-mounted lighting need in a widely accepted shape that blends with any architecture. The clean rectilinear design comes in four sizes with lumen packages ranging from 1,200 to 25,000 lumens, providing true site-wide solution.

WEDGE1 delivers up to 2,000 lumens with a soft, non-pixelated light source, creating a visually comfortable environment. The compact size of WEDGE1, with its integrated emergency battery backup option, makes it an ideal over-the-door wall-mounted lighting solution.

WEDGE LED Family Overview

Luminaire	Standard EM, 0°C	Cold EM, -20°C	Sensor	Lumens (4000K)					
				P1	P2	P3	P4	P5	P6
WEDGE1 LED	4W	--	--	1,200	2,000	--	--	--	--
WEDGE2 LED	10W	18W	Standalone / nLight	1,200	2,000	3,000	4,500	6,000	--
WEDGE3 LED	15W	18W	Standalone / nLight	7,500	8,500	10,000	12,000	--	--
WEDGE4 LED	--	--	Standalone / nLight	12,000	16,000	18,000	20,000	22,000	25,000

Ordering Information

EXAMPLE: WEDGE1 LED P2 40K 80CRI VF MVOLT SRM PE DDBXD

Series	Package	Color Temperature	CRI	Distribution	Voltage	Mounting
WEDGE1 LED	P0	27K 2700K	80CRI	VF Visual comfort forward throw	MVOLT	Shipped included SRM Surface mounting bracket ICW Indirect Canopy/Ceiling Washer bracket (dry/damp locations only) ⁵ Shipped separately AWS 3/8inch Architectural wall spacer PBBW Surface-mounted back box (top, left, right conduit entry) Use when there is no junction box available.
	P1	30K 3000K	90CRI	VW Visual comfort wide	347 ²	
	P2	35K 3500K				
		40K 4000K				
		50K ¹ 5000K				

Options	Finish
E4WH ³ Emergency battery backup, Certified in CA Title 20 MAEDBS (4W, 0°C min)	DDBXD Dark bronze
PE ⁴ Photocell, Button Type	DBLXD Black
DS Dual switching (comes with 2 drivers and 2 light engines; see page 3 for details)	DNAXD Natural aluminum
DMG 0-10V dimming wires pulled outside fixture (for use with an external control, ordered separately)	DWHXD White
BCE Bottom conduit entry for back box (PBBW). Total of 4 entry points.	DSSXD Sandstone
BAA Buy America(n) Act Compliant	DDBTXD Textured dark bronze
DSLE Dual Switching (1 Driver, 2 Light Engines)	DBLTXD Textured black
	DNATXD Textured natural aluminum
	DWHGXD Textured white
	DSSTXD Textured sandstone



COMMERCIAL OUTDOOR

One Lithonia Way • Conyers, Georgia 30012 • Phone: 1-800-705-SERV (7378) • www.lithonia.com
 © 2019-2023 Acuity Brands Lighting, Inc. All rights reserved.

WEDGE1 LED
 Rev. 11/16/23

Accessories

Ordered and shipped separately.

WDGEAWS DDBXD	WDGE 3/8inch Architectural Wall Spacer (specify finish)
WDGE1P8BW DDBXD U	WDGE1 surface-mounted back box (specify finish)

NOTES

- 50K not available in 90CRI.
- 347V not available with E4WH, DS, DSLE or PE.
- E4WH not available with PE or DS.
- PE not available with DS.
- Not qualified for DLC. Not available with E4WH.

Performance Data

Lumen Output

Lumen values are from photometric tests performed in accordance with IESNA LM-79-08. Data is considered to be representative of the configurations shown, within the tolerances allowed by Lighting Facts. Contact factory for performance data on any configurations not shown here.

Performance Package	System Watts	Dist. Type	27K (2700K, 80 CRI)					30K (3000K, 80 CRI)					35K (3500K, 80 CRI)					40K (4000K, 80 CRI)					50K (5000K, 80 CRI)				
			Lumens	LPW	B	U	G	Lumens	LPW	B	U	G	Lumens	LPW	B	U	G	Lumens	LPW	B	U	G	Lumens	LPW	B	U	G
P0	7W	VF	693	99	0	0	0	718	103	0	0	0	739	106	0	0	0	759	108	0	0	0	764	109	0	0	0
		VW	694	99	0	0	0	720	103	0	0	0	740	106	0	0	0	760	109	0	0	0	766	109	0	0	0
P1	10W	VF	1,120	112	0	0	0	1,161	116	0	0	0	1,194	119	0	0	0	1,227	123	0	0	0	1,235	123	0	0	0
		VW	1,122	112	0	0	0	1,163	116	0	0	0	1,196	120	0	0	0	1,229	123	0	0	0	1,237	124	0	0	0
P2	15W	VF	1,806	120	1	0	0	1,872	125	1	0	0	1,925	128	1	0	0	1,978	132	1	0	0	1,992	133	1	0	0
		VW	1,809	120	1	0	0	1,876	125	1	0	0	1,929	128	1	0	0	1,982	132	1	0	0	1,996	133	1	0	0

Electrical Load

Performance Package	System Watts	Current (A)				
		120V	208V	240V	277V	347V
P1	10W	0.082	0.049	0.043	0.038	--
	13W	--	--	--	--	0.046
P2	15W	0.132	0.081	0.072	0.064	--
	18W	--	--	--	--	0.056

Lumen Multiplier for 90CRI

CCT	Multiplier
27K	0.845
30K	0.867
35K	0.845
40K	0.885
50K	0.898

Lumen Output in Emergency Mode (4000K, 80 CRI)

Option	Dist. Type	Lumens
E4WH	VF	646
	VW	647

Lumen Ambient Temperature (LAT) Multipliers

Use these factors to determine relative lumen output for average ambient temperatures from 0-40°C (32-104°F).

Ambient	Lumen Multiplier
0°C / 32°F	1.03
10°C / 50°F	1.02
20°C / 68°F	1.01
25°C / 77°F	1.00
30°C / 86°F	0.99
40°C / 104°F	0.98

Projected LED Lumen Maintenance

Data references the extrapolated performance projections for the platforms noted in a 25°C ambient, based on 10,000 hours of LED testing (tested per IESNA LM-80-08 and projected per IESNA TM-21-11).

To calculate LLF, use the lumen maintenance factor that corresponds to the desired number of operating hours below. For other lumen maintenance values, contact factory.

Operating Hours	0	25,000	50,000	100,000
Lumen Maintenance Factor	1.0	>0.96	>0.95	>0.91



Photometric Diagrams

To see complete photometric reports or download .ies files for this product, visit the Lithonia Lighting WDGE LED homepage. Tested in accordance with IESNA LM-79 and LM-80 standards.

LEGEND

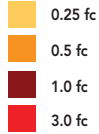

MH = 8ft
Grid = 8ft x 8ft

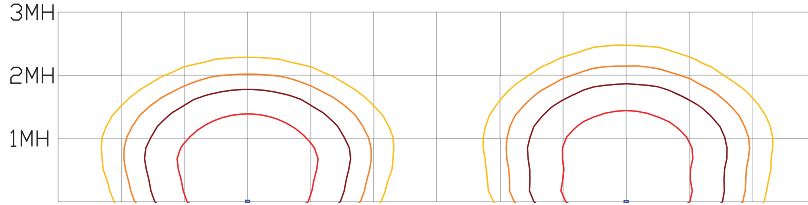

WDGE1 LED P2 40K 80CRI VW

WDGE1 LED P2 40K 80CRI VF

Emergency Egress Options

Emergency Battery Backup

The emergency battery backup is integral to the luminaire — no external housing required! This design provides reliable emergency operation while maintaining the aesthetics of the product. All emergency battery backup configurations include an independent secondary driver with an integral relay to immediately detect loss of normal power and automatically energize the luminaire. The emergency battery will power the luminaire for a minimum duration of 90 minutes (maximum duration of three hours) from the time normal power is lost and maintain a minimum of 60% of the light output at the end of 90minutes.

Applicable codes: NFPA 70/NEC – section 700.16, NFPA 101 Life Safety Code Section 7.9

The example below shows illuminance of 1 fc average and 0.1 fc minimum in emergency mode with E4WH and VF distribution.

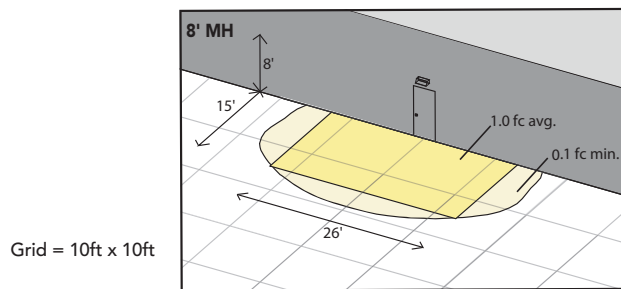

WDGE1 LED xx 40K 80CRI VF MVOLT E4WH

Dual Switching (DS) Option

The dual switching option offers operational redundancy that certain codes require. With this option the luminaire comes integrated with two drivers and two light engines. These work completely independent to each other so that a failure of any individual component does not cause the whole luminaire to go dark.

Applicable codes: NFPA 70/NEC – section 700.16, NFPA 101 Life Safety Code Section 7.9

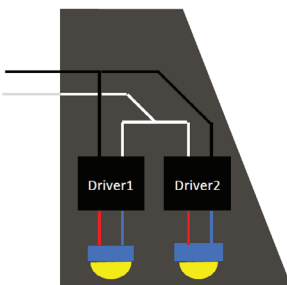

Dual Switching Light Engine (DSLE) Option

The dual switching option offers operational redundancy that certain codes require. With this option the luminaire comes integrated with one driver and two light engines. These work completely independent to each other so that a failure of either light engine does not cause the whole luminaire to go dark.

Applicable codes: NFPA 70/NEC – section 700.16, NFPA 101 Life Safety Code Section 7.9

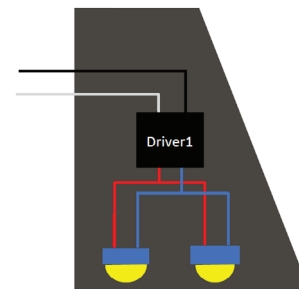



E4WH – 4W Emergency Battery Backup

D = 5.5"

H = 8"

W = 9"



PBBW – Surface-Mounted Back Box

Use when there is no junction box available.

D = 1.75"

H = 8"

W = 9"



AWS – 3/8inch Architectural Wall Spacer

D = 0.38"

H = 4.4"

W = 7.5"

FEATURES & SPECIFICATIONS

INTENDED USE

Common architectural look, with clean rectilinear shape, of the WDGE LED was designed to blend with any type of construction, whether it be tilt-up, frame or brick. Applications include commercial offices, warehouses, hospitals, schools, malls, restaurants, and other commercial buildings.

CONSTRUCTION

The single-piece die-cast aluminum housing integrates secondary heat sinks to optimize thermal transfer from the internal light engine heat sinks and promote long life. The driver is mounted in direct contact with the casting for a low operating temperature and long life. The die-cast door frame is fully gasketed with a one-piece solid silicone gasket to keep out moisture and dust, providing an IP66 rating for the luminaire.

FINISH

Exterior painted parts are protected by a zinc-infused Super Durable TGIC thermoset powder coat finish that provides superior resistance to corrosion and weathering. A tightly controlled multi-stage process ensures a 3 mils thickness for a finish that can withstand extreme climate changes without cracking or peeling. Standard Super Durable colors include dark bronze, black, natural aluminum, sandstone and white. Available in textured and non-textured finishes.

OPTICS

Well crafted reflector optics allow the light engine to be recessed within the luminaire, providing visual comfort, superior distribution, uniformity, and spacing in wall-mount applications. The WDGE LED has zero uplight and qualifies as a Nighttime Friendly™ product, meaning it is consistent with the LEED® and Green Globes™ criteria for eliminating wasteful uplight.

ELECTRICAL

Light engine consists of high-efficiency LEDs mounted to metal-core circuit boards to maximize heat dissipation and promote long life (up to L91/100,000 hours at 25°C). The electronic driver has a power factor of >90%, THD <20%. Luminaire comes with built in 6kV surge protection, which meets a minimum Category C low exposure (per ANSI/IEEE C62.41.2). Fixture ships standard with 0-10v dimmable driver.

INSTALLATION

A universal mounting plate with integral mounting support arms allows the fixture to hinge down for easy access while making wiring connections. The 3/8" Architectural Wall Spacer (AWS) can be used to create a floating appearance or to accommodate small imperfections in the wall surface. The ICW option can be used to mount the luminaire inverted for indirect lighting in dry and damp locations. Design can withstand up to a 1.5 G vibration load rating per ANSI C136.31.

LISTINGS

CSA certified to U.S. and Canadian standards. Luminaire is IP66 rated. PIR options are rated for wet location. Rated for -40°C minimum ambient. DesignLights Consortium® (DLC) Premium qualified product and DLC qualified product. Not all versions of this product may be DLC Premium qualified or DLC qualified. Please check the DLC Qualified Products List at www.designlights.org/QPL to confirm which versions are qualified. International Dark-Sky Association (IDA) Fixture Seal of Approval (FSA) is available for all products on this page utilizing 2700K and 3000K color temperature only and SRM mounting only.

BUY AMERICAN ACT

Product with the BAA option is assembled in the USA and meets the Buy America(n) government procurement requirements under FAR, DFARS and DOT regulations. Please refer to www.acuitybrands.com/buy-american for additional information.

WARRANTY

5-year limited warranty. This is the only warranty provided and no other statements in this specification sheet create any warranty of any kind. All other express and implied warranties are disclaimed. Complete warranty terms located at: www.acuitybrands.com/support/warranty/terms-and-conditions

Note: Actual performance may differ as a result of end-user environment and application. All values are design or typical values, measured under laboratory conditions at 25 °C. Specifications subject to change without notice.

TYPE: _____ QUANTITY: _____ PROJECT: _____

CATALOG NUMBER:

FIXTURE SUFFIX REFLECTOR VOLTAGE FINISH OPTION OPTION OPTION

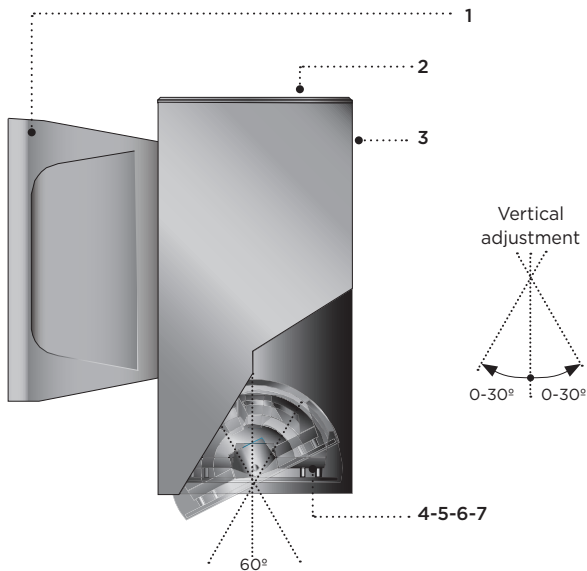

- 1- Cast aluminum driver housing. Includes galvanized steel wall mount pressure plate.
- 2- Cast aluminum ventilated top cover.
- 3- Seamless extruded aluminum housing.
- 4- Fully sealed cast aluminum up or down light assembly.
- 5- Sealed cast aluminum lens frame.
- 6- Clear tempered glass lens.
- 7- Faceted specular aluminum reflector.

SQ600



All stainless steel hardware.

Syrios Square light module is designed with a tilting mechanism allowing forward and back light adjustability. The $\pm 30^\circ$ directional module allows to aim the light beam in the desired direction, without disturbing the luminaire mounting. The module can be secured using the built in locking mechanism.



Other adjustment factory set positions are available. Please consult factory.

MATERIALS

Syrios Square is made of corrosion resistant 356 aluminum alloy with a copper (CU) content of less than 0.1%. The main housing is made of seamless extruded aluminum, with an integrally sealed LED light module designed for optimal heat dissipation, and lighting performance. Syrios Square is standard with a unique proprietary design allowing the sealed LED module to tilt within the housing. The top cast aluminum cover includes ventilation slots allowing air circulation and cooling of assembly. Syrios Square SQ600 series is standard with 30° optic. See options section for alternate selection.

ELECTRICAL

DRIVER Standard driver is 0-10V dimming-ready (dims to 10%) with: 120-277 multi-volt compatibility (50-60Hz), operating temperature range of -40°C/-40°F to 55°C/131°F, output over voltage protection, output over current protection and output short circuit protection with auto-recovery.

LED Standard 4000K/80CRI. Optional 2700K, 3000K & 3500K. Optional Amber LED for turtle sensitive areas. Wavelengths: 584.5nm to 597nm.

LIFE

60,000hrs $L_{70}B_{50}$ (based on IESNA TM-21 Test Method and LM-80 data). Up to 70,000hrs $L_{70}B_{50}$ (calculated projection from LM-80 data).

FINISH

Five-stage preparation process includes preheating of cast aluminum parts for air extraction. Polyester powder coating is applied through an electrostatic process, and oven cured for long term finish.

MOUNTING

Maximum weight: 9.5 lbs (4.3 kg)
The mounting plate is designed to fit on a 4" (102mm) octagonal electrical box using 3.5" (89mm) C/C mounting holes. Additional mounting holes are provided as per site requirements.

CERTIFICATION

Certified and approved as per CSA C22.2 No.: 250.0 standard and ANSI/UL 1598 standard, for wet location. Rated IP66.

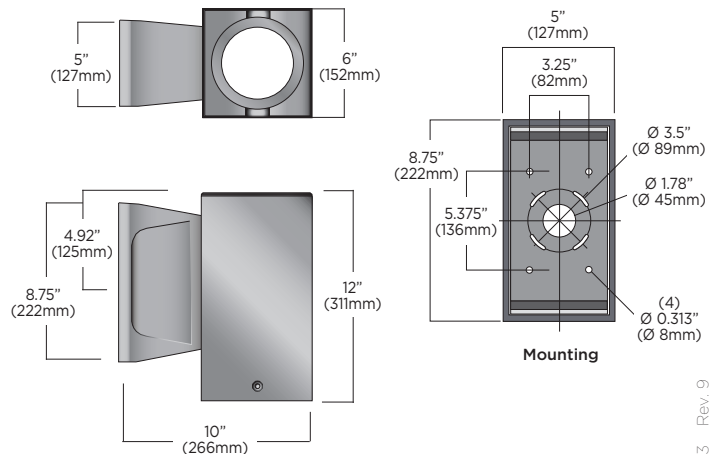

LUMINAIRE SELECTION

1 MODEL#  <input type="checkbox"/> SQ600	2 LED LIGHT SELECTION <table border="1"> <thead> <tr> <th>SUFFIX</th> <th>DELIVERED LUMENS</th> <th>INPUT WATTS</th> <th>CRI</th> <th>CCT °K</th> </tr> </thead> <tbody> <tr> <td><input type="checkbox"/> L1L15</td> <td>1599</td> <td>15W</td> <td>80</td> <td>4000</td> </tr> <tr> <td><input type="checkbox"/> L1L25</td> <td>2543</td> <td>26W</td> <td>80</td> <td>4000</td> </tr> <tr> <td><input type="checkbox"/> L1L40</td> <td>4102</td> <td>48W</td> <td>80</td> <td>4000</td> </tr> <tr> <td colspan="5">AMBER LED</td> </tr> <tr> <td><input type="checkbox"/> L1L3K2A</td> <td>263</td> <td>11W</td> <td>AMBER</td> <td></td> </tr> </tbody> </table> <table border="1"> <thead> <tr> <th colspan="5">VERY NARROW DISTRIBUTION</th> </tr> </thead> <tbody> <tr> <td><input type="checkbox"/> L1L20NR</td> <td>1690</td> <td>31W</td> <td>80</td> <td>4000</td> </tr> </tbody> </table>	SUFFIX	DELIVERED LUMENS	INPUT WATTS	CRI	CCT °K	<input type="checkbox"/> L1L15	1599	15W	80	4000	<input type="checkbox"/> L1L25	2543	26W	80	4000	<input type="checkbox"/> L1L40	4102	48W	80	4000	AMBER LED					<input type="checkbox"/> L1L3K2A	263	11W	AMBER		VERY NARROW DISTRIBUTION					<input type="checkbox"/> L1L20NR	1690	31W	80	4000	3 REFLECTORS* <input type="checkbox"/> R15 Narrow optics 15° <input type="checkbox"/> R30 Flood optics 30° (standard) <input type="checkbox"/> R55 Wide flood optics 52° <small>*Depending on direction fixture is installed add U (for uplight) or D (for downlight) to suffix for all reflectors listed above. (i.e. R55U is 52° uplight)</small> <input type="checkbox"/> R9 Very narrow optics 9° Field angle 18° (46,151 candela)	4 VOLTAGE <input type="checkbox"/> 120V <input type="checkbox"/> 277V Optional <input type="checkbox"/> 347V ⁴	5 FINISH STANDARD COLORS* <input type="checkbox"/> WHT Snow white <input type="checkbox"/> BKT Jet black <input type="checkbox"/> BZT Bronze <input type="checkbox"/> MST Matte silver <input type="checkbox"/> GRT Titanium gray <input type="checkbox"/> DGT Gun metal <input type="checkbox"/> CHT Champagne <input type="checkbox"/> SGT Steel gray <input type="checkbox"/> BGT English cream OPTIONAL COLORS <input type="checkbox"/> CS Custom color <input type="checkbox"/> RAL RAL# color ENVIRONMENT <input type="checkbox"/> MG Marine grade ⁸ <input type="checkbox"/> NT Natatorium ⁹ <small>*Refer to color chart</small>
SUFFIX	DELIVERED LUMENS	INPUT WATTS	CRI	CCT °K																																								
<input type="checkbox"/> L1L15	1599	15W	80	4000																																								
<input type="checkbox"/> L1L25	2543	26W	80	4000																																								
<input type="checkbox"/> L1L40	4102	48W	80	4000																																								
AMBER LED																																												
<input type="checkbox"/> L1L3K2A	263	11W	AMBER																																									
VERY NARROW DISTRIBUTION																																												
<input type="checkbox"/> L1L20NR	1690	31W	80	4000																																								

OPTIONS

ELECTRICAL

- FS** Fuse
- PH** Photocell¹
- MS** PIR motion sensor (Device is located at bottom of luminaire wall box)³
- REML2-50** 7W remote emergency battery backup for LED, 90 min. Remote mount 50ft - 12" (305mm) square enclosure with access cover²

LIGHT & OPTICS

Alternate CCT °K LED (LCF: Lumen conversion factor)

- K27** 2700K CCT 80 CRI (LCF: 0.91)⁵
- K3** 3000K CCT 80 CRI (LCF: 0.94)
- K35** 3500K CCT 80 CRI (LCF: 0.983)⁵
- AR180** Light module with side to side adjustment

FAUX WOOD COLORS⁶

- | | |
|--|--|
| <input type="checkbox"/> ADG American douglas | <input type="checkbox"/> MPL Maple |
| <input type="checkbox"/> BRC Birch | <input type="checkbox"/> OFL Oak |
| <input type="checkbox"/> CHN Chestnut | <input type="checkbox"/> RSW Rosewood |
| <input type="checkbox"/> CRY Cherry | <input type="checkbox"/> TEK Teak |
| <input type="checkbox"/> KNP Knotty pine | <input type="checkbox"/> WLN Walnut |

ACCESSORIES

- HL** Hexcell louver
- SL** Solite lens (light loss factor [LLF]: 0.9)
- LSL** Linear spread lens (Asymmetric lens distribution is achieved when light module is tilted)

MOUNTING

- SWK** Adaptor box for surface 3/4" conduit feed (4 sides plus back entry)
- UP** Option required for uplight installation
- UH** Uniform height matching SQ602⁷



For IDA certification compliance, luminaire must be ordered with 3000K or warmer.

NOTES

- 1- Photocell (PH) not available with REML2-50 option.
- 2- The remote enclosure must be interior.
- 3- PIR motion sensor (MS) not available with REML2-50 option.
- 4- 347V not compatible with Amber LED L1L3K2A.
- 5- K27 and K35 options not available with the R9 optics.
- 6- Faux wood finish not applied to driver housing, lens frame or accessories.
- 7- For UH with AR180 consult factory.
- 8- For harsh, coastal environment and exposure to salt water. Longer lead time may apply please contact factory for info.
- 9- Only available in WHT and BKT.

TYPICAL PHOTOMETRY SUMMARY

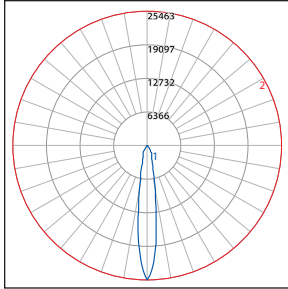

Descriptive information

SQ600-L1L40-R15
 Total Lms: 3998 lumens
 Total input watts: 48 W
 Efficacy: 83 Lumens/Watt
 BUG: B3-UO-GO
 CCT/CRI: 4000K/80
 Maximum candela: 25463 @ 0°

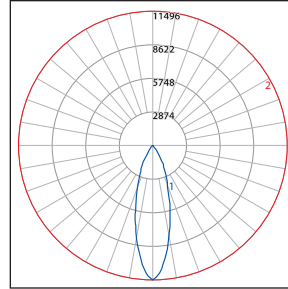

Descriptive information

SQ600-L1L40-R30
 Total Lms: 4102 lumens
 Total input watts: 48 W
 Efficacy: 85 Lumens/Watt
 BUG: B3-UO-GO
 CCT/CRI: 4000K/80
 Maximum candela: 11496 @ 0°

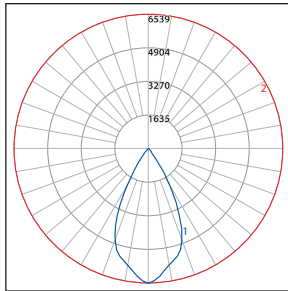

Descriptive information

SQ600-L1L40-R55
 Total Lms: 4369 lumens
 Total input watts: 48 W
 Efficacy: 91 Lumens/Watt
 BUG: B3-UO-GO
 CCT/CRI: 4000K/80
 Maximum candela: 6539 @ 0°

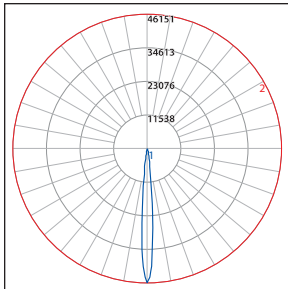

Descriptive information

SQ600-L1L20NR-R9
 Total Lms: 1690 lumens
 Total input watts: 31 W
 Efficacy: 55 Lumens/Watt
 BUG: B2-UO-GO
 CCT/CRI: 4000K/80
 Maximum candela: 46151 @ 0°

Please visit our web site www.luminis.com for complete I.E.S. formatted download data.



RSX1 LED Area Luminaire



Catalog Number
Notes
Type

Hit the Tab key or mouse over the page to see all interactive elements.

Specifications

EPA (ft ² @0°):	0.57 ft ² (0.05 m ²)
Length:	21.8" (55.4 cm) (SPA mount)
Width:	13.3" (33.8 cm)
Height:	3.0" (7.6 cm) Main Body 7.2" (18.4 cm) Arm
Weight: (SPA mount):	22.0 lbs (10.0 kg)

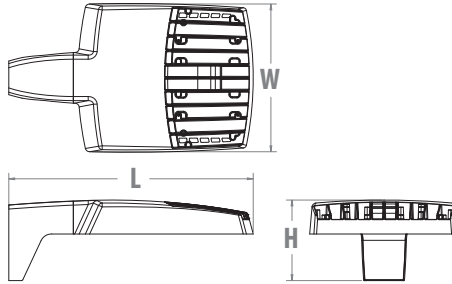

Introduction

The new RSX LED Area family delivers maximum value by providing significant energy savings, long life and outstanding photometric performance at an affordable price. The RSX1 delivers 7,000 to 17,000 lumens allowing it to replace 70W to 400W HID luminaires.

The RSX features an integral universal mounting mechanism that allows the luminaire to be mounted on most existing drill hole patterns. This "no-drill" solution provides significant labor savings. An easy-access door on the bottom of mounting arm allows for wiring without opening the electrical compartment. A mast arm adaptor, adjustable integral slipfitter and other mounting configurations are available.

ds Design Select options indicated by this color background.



Items marked by a shaded background qualify for the Design Select program and ship in 15 days or less. To learn more about Design Select, visit www.acuitybrands.com/designselect. *See ordering tree for details

Ordering Information

EXAMPLE: RSX1 LED P4 40K R3 MVOLT SPA DDBXD

RSX1 LED						
Series	Performance Package	Color Temperature	Distribution	Voltage	Mounting	
RSX1 LED	P1	30K 3000K	R2 Type 2 Wide	MVOLT (120V-277V) ²	SPA Square pole mounting (3.0" min. SQ pole for 1 at 90°, 3.5" min. SQ pole for 2, 3, 4 at 90°) RPA Round pole mounting (3.2" min. dia. RND pole for 2, 3, 4 at 90°, 3.0" min. dia. RND pole for 1 at 90°, 2 at 180°, 3 at 120°) MA Mast arm adaptor (fits 2-3/8" OD horizontal tenon) IS Adjustable slipfitter (fits 2-3/8" OD tenon) ⁶ WBA Wall bracket ¹ WBASC Wall bracket with surface conduit box AASP Adjustable tilt arm square pole mounting ⁶ AARP Adjustable tilt arm round pole mounting ⁶ AAWB Adjustable tilt arm with wall bracket ⁶ AAWSC Adjustable tilt arm wall bracket and surface conduit box ⁶	
	P2	40K 4000K	R3 Type 3 Wide	HVOLT (347V-480V) ³		
	P3	50K 5000K	R3S Type 3 Short	XVOLT (277V-480V) ⁴		
	P4	R4 Type 4 Wide	(use specific voltage for options as noted)			
		R4S Type 4 Short				120 ³ 277 ⁵
		R5 Type 5 Wide ¹				208 ³ 347 ⁵
		R5S Type 5 Short ¹				240 ³ 480 ⁵
		AFR Automotive Front Row				
		AFRR90 Automotive Front Row Right Rotated				
	AFRL90 Automotive Front Row Left Rotated					

Options	Finish
Shipped Installed HS House-side shield ⁷ PE Photocontrol, button style ^{8,9} PER7 Seven-wire twist-lock receptacle only (no controls) ^{9,10,11} SF Single fuse (120, 277, 347) ⁵ DF Double fuse (208, 240, 480) ⁵ SPD20KV 20KV Surge pack (10KV standard) FAO Field adjustable output ⁹ DMG 0-10V dimming extend out back of housing for external control (control ordered separate) ⁹	DDBXD Dark Bronze DBLXD Black DNAXD Natural Aluminum DWHXD White DDBTXD Textured Dark Bronze DBLTXD Textured Black DNATXD Textured Natural Aluminum DWHGXD Textured White
Shipped Separately (requires some field assembly) EGS External glare shield ⁷ EGFV External glare full visor (360° around light aperture) ⁷ BS Bird spikes ¹⁶	



Ordering Information

Accessories

Ordered and shipped separately.

RSX1HS	RSX1 House side shield (includes 1 shield)
RSX1HSAFR U	RSX1 House side shield for AFR rotated optics (includes 1 shield)
RSX1EGS (FINISH) U	External glare shield (specify finish)
RSX1EGFV (FINISH) U	External glare full visor (specify finish)
RSXRPA (FINISH) U	RSX Universal round pole adaptor plate (specify finish)
RSXWBA (FINISH) U	RSX WBA wall bracket (specify finish) ¹
RSXSGB (FINISH) U	RSX Surface conduit box (specify finish, for use with WBA, WBA not included)
DLL127F 1.5 JU	Photocell -SSL twist-lock (120-277V) ¹⁷
DLL347F 1.5 CUL JU	Photocell -SSL twist-lock (347V) ¹⁷
DLL480F 1.5 CUL JU	Photocell -SSL twist-lock (480V) ¹⁷
DSHORT SBK U	Shorting cap ¹⁷

NOTES

- Any Type 5 distribution, is not available with WBA.
- MVOLT driver operates on any line voltage from 120-277V (50/60 Hz).
- HVOLT driver operates on any line voltage from 347-480V (50/60 Hz).
- XVOLT driver not available with P1 or P2. XVOLT driver operates on any line voltage from 277V-480V (50/60 Hz). XVOLT not available with fusing (SF or DF) and not available with PE.
- Single fuse (SF) requires 120V, 277V or 347V. Double fuse (DF) requires 208V, 240V or 480V.
- Maximum tilt is 90° above horizontal.
- It may be ordered as an accessory.
- Requires MVOLT or 347V.
- Two or more of the following options cannot be combined including PE, DMG, PER7, FAO and NLTAIR2 PIRHN. (Exception: PE and FAO can be combined; also PE and DMG can be combined.)
- Compatible with standard twist-lock photocells for dusk to dawn operation or advanced control nodes that provide 0-10V dimming

- signals. Wire 4/Wire 5 wired to dimming leads on driver. Wire6/Wire7 capped inside luminaire. Twistlock photocell ordered and shipped as a separate line item from Acuity Brands Controls. See accessories. Shorting Cap included.
- For units with option PER7, the mounting must be restricted to +/- 45° from horizontal aim per ANSI C136.10-2010.
 - Must be ordered with PIRHN.
 - Requires MVOLT or HVOLT.
 - Must be ordered with NLTAIR2. For additional information on PIRHN visit [here](#).
 - CCE option not available with WBA, WBASC, AASP, AARP, AAWB, AAWBSC, EGS, EGFV and BS.
 - Must be ordered with fixture for factory pre-drilling.
 - Requires luminaire to be specified with PER7 option. Ordered and shipped as a separate line item from Acuity Brands Controls.

External Shields



House Side Shield



External Glare Shield



External 360 Full Visor

Pole/Mounting Information

Accessories including bullhorns, cross arms and other adapters are available under the accessories tab at Lithonia's Outdoor Poles and Arms product page. Click here to visit [Accessories](#).

HANDHOLE ORIENTATION

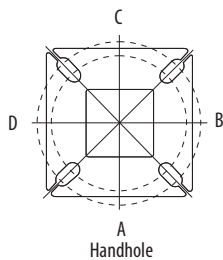

Handhole

RSX POLE DRILLING

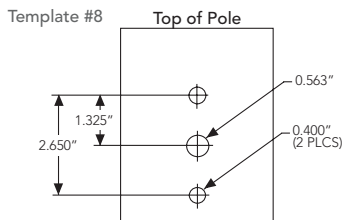

RSX STANDARD ARM & ADJUSTABLE ARM

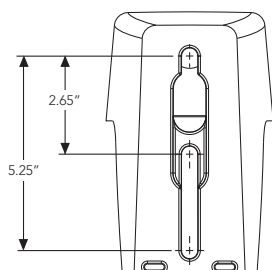

Round Tenon Mount - Pole Top Slipfitters

Tenon O.D.	RSX Mounting	Single	2 @ 180°	2 @ 90°	3 @ 120°	3 @ 90°	4 @ 90°
2 - 3/8"	RPA, AARP	AS3-5 190	AS3-5 280	AS3-5 290	AS3-5 320	AS3-5 390	AS3-5 490
2 - 7/8"	RPA, AARP	AST25-190	AST25-280	AST25-290	AST25-320	AST25-390	AST25-490
4"	RPA, AARP	AST35-190	AST35-280	AST35-290	AST35-320	AST35-390	AST35-490

Drill/Side Location by Configuration Type

Drilling Template	Mounting Option	Single	2 @ 180	2 @ 90	3 @ 120	3 @ 90	4 @ 90
#8	Head Location	Side B	Side B & D	Side B & C	Round Pole Only	Side B, C & D	Side A, B, C & D
#8	Drill Nomenclature	DM19AS	DM28AS	DM29AS	DM32AS	DM39AS	DM49AS

RSX1 - Luminaire EPA

*Includes luminaire and integral mounting arm. Other tenons, arms, brackets or other accessories are not included in this EPA data.

Fixture Quantity & Mounting Configuration	Single	2 @ 90	2 @ 180	3 @ 90	3 @ 120	4 @ 90	2 Side by Side	3 Side by Side	4 Side by Side
SPA - Square Pole Adaptor	0.57	1.03	1.05	1.52	1.36	2.03	1.31	1.7	2.26
RPA - Round Pole Adaptor	0.62	1.08	1.15	1.62	1.46	2.13	1.36	1.8	2.36
MA - Mast Arm Adaptor	0.49	0.95	0.89	1.36	1.2	1.87	1.23	1.54	2.1
IS - Integral Slipfitter	0.57	1.03	1.05	1.52	1.36	2.03	1.31	1.7	2.26
AASP/AARP - Adjustable Arm Square/Round Pole	0°	0.68	1.34	1.33	2	1.74	2.64	1.35	2.03
	10°	0.87	1.71	1.73	2.56	2.26	3.42	1.75	2.62
	20°	1.24	2.19	2.3	3.21	2.87	4.36	2.49	3.73
	30°	1.81	2.68	2.98	3.85	3.68	5.30	3.62	5.43
	40°	2.11	2.92	3.44	4.2	4.08	5.77	4.22	6.33
	45°	2.31	3.17	3.72	4.52	4.44	6.26	4.62	6.94
	50°	2.71	3.66	4.38	5.21	5.15	7.24	5.43	8.14
	60°	2.78	3.98	4.54	5.67	5.47	7.91	5.52	8.27
	70°	2.76	4.18	4.62	5.97	5.76	8.31	5.51	8.27
	80°	2.73	4.25	4.64	6.11	5.91	8.47	5.45	8.18
	90°								

Isofootcandle plots for the RSX1 LED P4 40K. Distances are in units of mounting height (20').

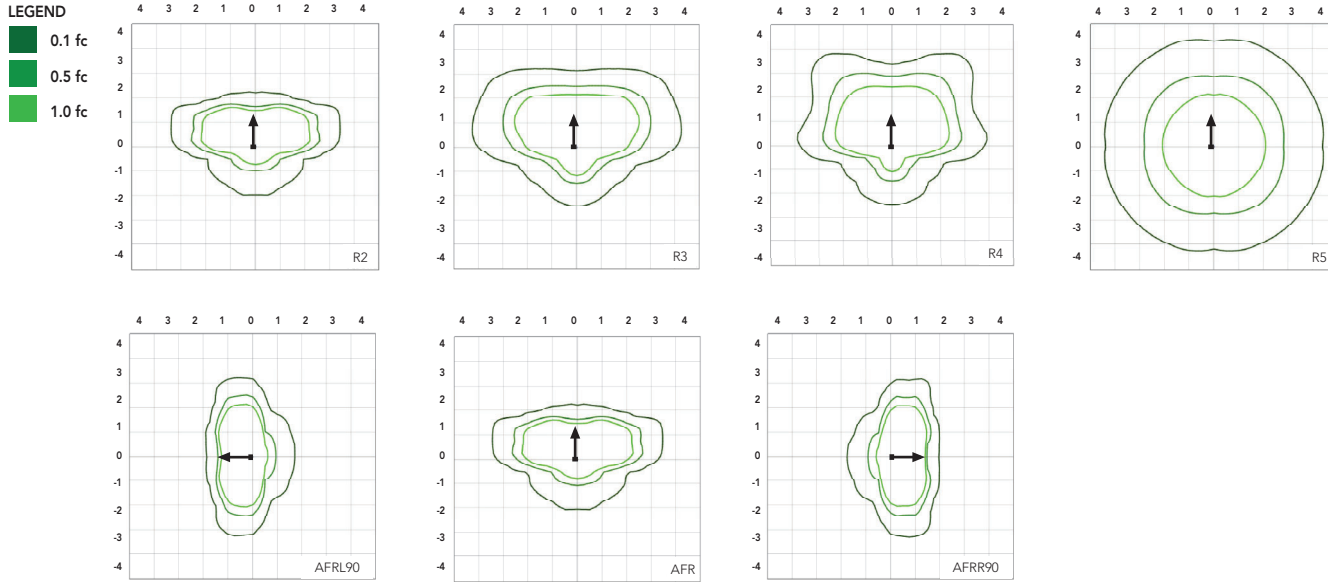

Performance Data

Lumen Ambient Temperature (LAT) Multipliers

Use these factors to determine relative lumen output for average ambient temperatures from 0-50°C (32-122°F).

Ambient	Ambient	Lumen Multiplier
0°C	32°F	1.05
5°C	41°F	1.04
10°C	50°F	1.03
15°C	59°F	1.02
20°C	68°F	1.01
25°C	77°F	1.00
30°C	86°F	0.99
35°C	95°F	0.98
40°C	104°F	0.97
45°C	113°F	0.96
50°C	122°F	0.95

Electrical Load

Performance Package	System Watts (W)	Current (A)					
		120V	208V	240V	277V	347V	480V
P1	51W	0.42	0.25	0.21	0.19	0.14	0.11
P2	72W	0.60	0.35	0.30	0.26	0.21	0.15
P3	109W	0.91	0.52	0.45	0.39	0.31	0.23
P4	133W	1.11	0.64	0.55	0.48	0.38	0.27

Projected LED Lumen Maintenance

Operating Hours	50,000	75,000	100,000
Lumen Maintenance Factor	>0.97	>0.95	>0.92

Values calculated according to IESNA TM-21-11 methodology and valid up to 40°C.

Lumen Output

Lumen values are from photometric tests performed in accordance with IESNA LM-79-08. Data is considered to be representative of the configurations shown, within the tolerances allowed by Lighting Facts. Contact factory for performance data on any configurations not shown here.

Performance Package	System Watts	Distribution Type	30K (3000K, 70 CRI)					40K (4000K, 70 CRI)					50K (5000K, 70 CRI)				
			Lumens	B	U	G	LPW	Lumens	B	U	G	LPW	Lumens	B	U	G	LPW
P1	51W	R2	6,482	1	0	1	126	7,121	1	0	1	139	7,121	1	0	1	139
		R3	6,459	1	0	2	127	7,096	1	0	2	139	7,096	1	0	2	139
		R35	6,631	1	0	1	129	7,286	1	0	2	142	7,286	1	0	2	142
		R4	6,543	1	0	2	128	7,189	1	0	2	141	7,189	1	0	2	141
		R45	6,313	1	0	1	124	6,936	1	0	1	136	6,936	1	0	1	136
		R5	6,631	3	0	2	130	7,286	3	0	2	143	7,286	3	0	2	143
		R55	6,807	3	0	1	133	7,479	3	0	1	147	7,479	3	0	1	147
		AFR	6,473	1	0	1	127	7,112	1	0	1	139	7,112	1	0	1	139
		AFRR90	6,535	2	0	2	127	7,179	2	0	2	140	7,179	2	0	2	140
AFRL90	6,562	2	0	1	128	7,210	2	0	2	140	7,210	2	0	2	140		
P2	72W	R2	8,991	2	0	1	123	9,878	2	0	1	135	9,878	2	0	1	135
		R3	8,959	2	0	2	124	9,843	2	0	2	137	9,843	2	0	2	137
		R35	9,198	2	0	2	126	10,106	2	0	2	139	10,106	2	0	2	139
		R4	9,077	2	0	2	126	9,972	2	0	2	139	9,972	2	0	2	139
		R45	8,757	1	0	2	122	9,622	2	0	2	134	9,622	2	0	2	134
		R5	9,198	4	0	2	128	10,106	4	0	2	140	10,106	4	0	2	140
		R55	9,443	3	0	1	131	10,374	3	0	1	144	10,374	3	0	1	144
		AFR	8,979	2	0	1	125	9,865	2	0	1	137	9,865	2	0	1	137
		AFRR90	9,064	3	0	2	124	9,959	3	0	2	137	9,959	3	0	2	137
AFRL90	9,102	3	0	2	125	10,001	3	0	2	137	10,001	3	0	2	137		
P3	109W	R2	12,808	2	0	1	117	14,072	2	0	2	129	14,072	2	0	2	129
		R3	12,763	2	0	2	117	14,023	2	0	2	129	14,023	2	0	2	129
		R35	13,104	2	0	2	120	14,397	2	0	2	132	14,397	2	0	2	132
		R4	12,930	2	0	2	119	14,206	2	0	2	130	14,206	2	0	2	130
		R45	12,475	2	0	2	114	13,707	2	0	2	126	13,707	2	0	2	126
		R5	13,104	4	0	2	120	14,397	4	0	2	132	14,397	4	0	2	132
		R55	13,452	3	0	2	123	14,779	3	0	2	136	14,779	3	0	2	136
		AFR	12,791	2	0	1	117	14,053	2	0	2	129	14,053	2	0	2	129
		AFRR90	12,913	3	0	3	118	14,187	3	0	3	130	14,187	3	0	3	130
AFRL90	12,967	3	0	2	118	14,247	3	0	3	130	14,247	3	0	3	130		
P4	133W	R2	14,943	2	0	2	112	16,417	2	0	2	123	16,417	2	0	2	123
		R3	14,890	2	0	3	112	16,360	2	0	3	123	16,360	2	0	3	123
		R35	15,287	2	0	2	115	16,796	2	0	2	126	16,796	2	0	2	126
		R4	15,085	2	0	3	113	16,574	2	0	3	125	16,574	2	0	3	125
		R45	14,554	2	0	2	109	15,991	2	0	2	120	15,991	2	0	2	120
		R5	15,287	4	0	2	115	16,796	4	0	2	126	16,796	4	0	2	126
		R55	15,693	4	0	2	118	17,242	4	0	2	130	17,242	4	0	2	130
		AFR	14,923	2	0	2	112	16,395	2	0	2	123	16,395	2	0	2	123
		AFRR90	15,065	3	0	3	113	16,551	3	0	3	124	16,551	3	0	3	124
AFRL90	15,128	3	0	3	114	16,621	3	0	3	125	16,621	3	0	3	125		

Dimensions & Weights

Luminaire Weight by Mounting Type

Mounting Configuration	Total Luminaire Weight
SPA	22 lbs
RPA	24 lbs
MA	22 lbs
WBA	25 lbs
WBASC	28 lbs
IS	25 lbs
AASP	25 lbs
AARP	27 lbs
AAWB	28 lbs
AAWSC	31 lbs

RSX1 with Round Pole Adapter (RPA)

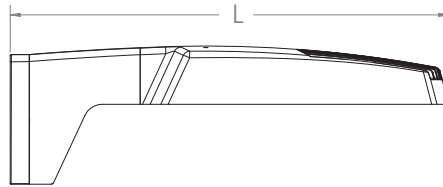
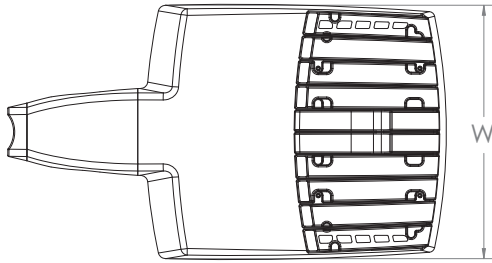

Note: RPA — Round Pole mount can also be used to mount on square poles by omitting the round pole adapter plate shown here.



Length: 22.8" (57.9 cm)
 Width: 13.3" (33.8 cm)
 Height: 3.0" (7.6 cm) Main Body
 7.2" (18.4 cm) Arm

RSX1 with Mast Arm Adapter (MA)

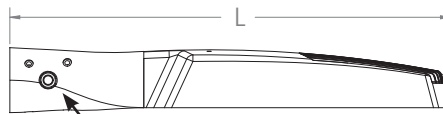
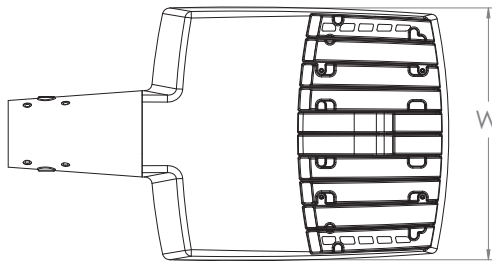

7/16" locking thru bolt/nut provided

Length: 23.2" (59.1 cm)
 Width: 13.3" (33.8 cm)
 Height: 3.0" (7.6 cm) Main Body
 3.5" (8.9 cm) Arm

RSX1 with Adjustable Slipfitter (IS)

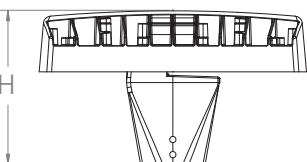
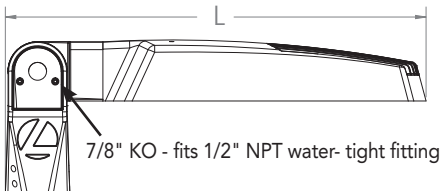
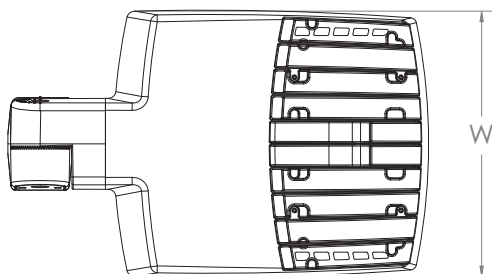

7/8" KO - fits 1/2" NPT water-tight fitting

Length: 20.7" (52.7 cm)
 Width: 13.3" (33.8 cm)
 Height: 3.0" (7.6 cm) Main Body
 7.6" (19.3 cm) Arm

Dimensions

RSX1 with Wall Bracket (WBA)

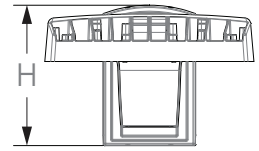
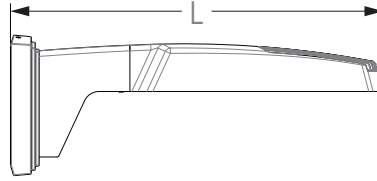
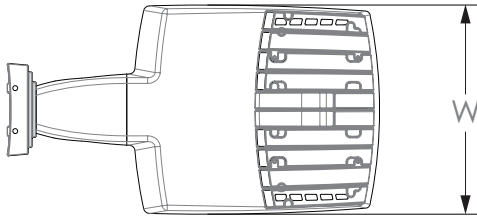

Length: 23.6" (59.9 cm)
 Width: 13.3" (33.8 cm)
 Height: 3.0" (7.6 cm) Main Body
 8.9" (22.6 cm) Arm

Wall Bracket (WBA) Mounting Detail

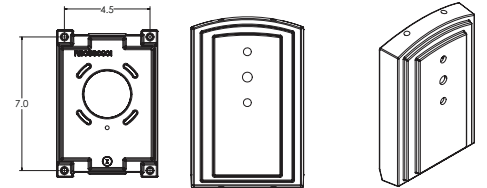

RSX1 with Wall Bracket with Surface Conduit Box (WBASC)

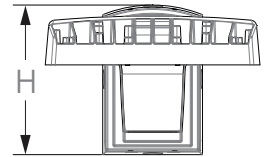
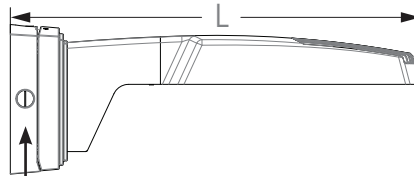
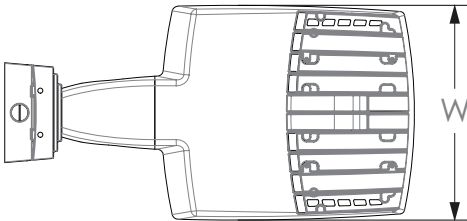

3/4" NPT taps with plugs - Qty (4) provided

Length: 25.3" (64.3 cm)
 Width: 13.3" (33.8 cm)
 Height: 3.0" (7.6 cm) Main Body
 9.2" (23.4 cm) Arm

Surface Conduit Box (SCB) Mounting Detail

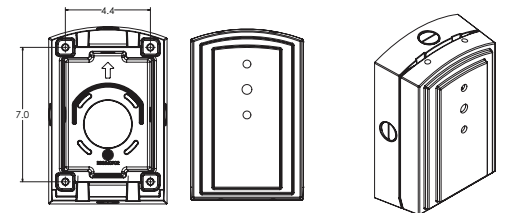

Dimensions

RSX1 with Adjustable Tilt Arm - Square or Round Pole (AASP or AARP)

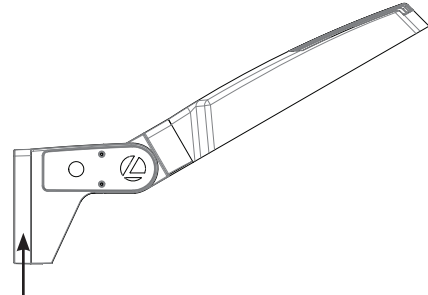
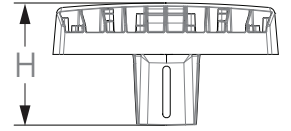
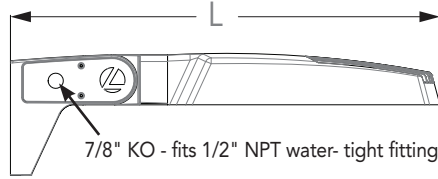
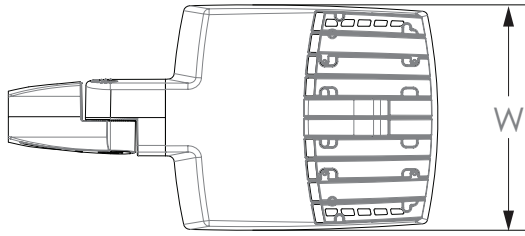

NOTE:
RPA - Round Pole mount can also be used to mount on square poles by omitting the round pole adapter plate shown here.



Length: 25.3" (65.3 cm) **AASP**
26.3" (66.8 cm) **AARP**
Width: 13.3" (33.8 cm)
Height: 3.0" (7.6 cm) Main Body
7.2" (18.2 cm) Arm

Notes

AASP: Requires 3.0" min. square pole for 1 at 90°. Requires 3.5" min. square pole for mounting 2, 3, 4 at 90°.

AARP: Requires 3.2" min. dia. round pole for 2, 3, 4 at 90°. Requires 3.0" min. dia. round pole for mounting 1 at 90°, 2 at 180°, 3 at 120°.

RSX1 with Adjustable Tilt Arm with Wall Bracket (AAWB)

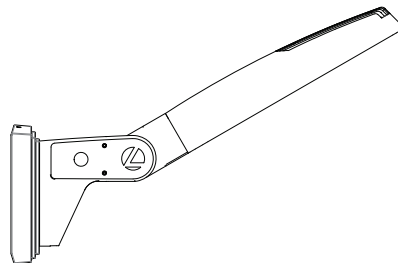
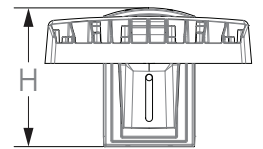
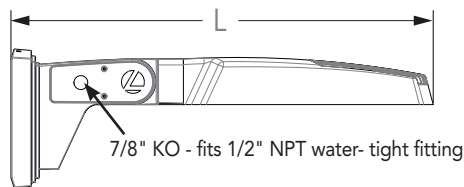
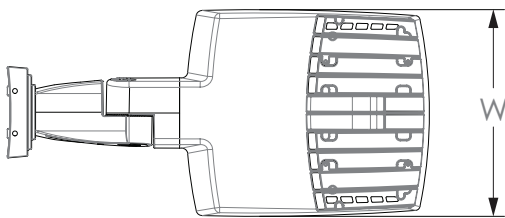

Wall Bracket (WBA) Mounting Detail

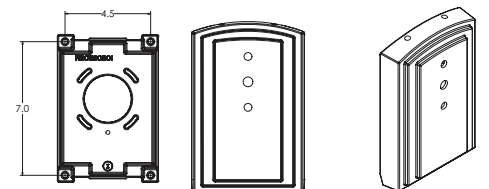

Length: 27.1" (68.8 cm)
Width: 13.3" (33.8 cm)
Height: 3.0" (7.6 cm) Main Body
8.9" (22.6 cm) Arm

Dimensions

RSX1 with Adjustable Tilt Arm with Wall Bracket and Surface Conduit Box (AAWSC)

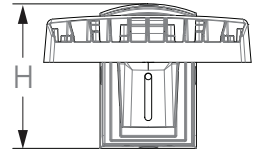
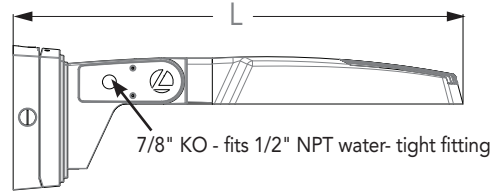
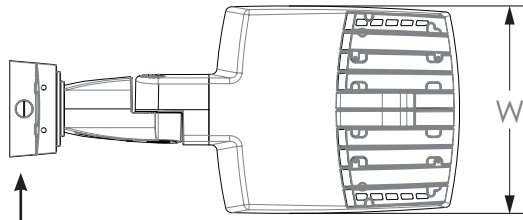

3/4" NPT taps with plugs - Qty (4) provided

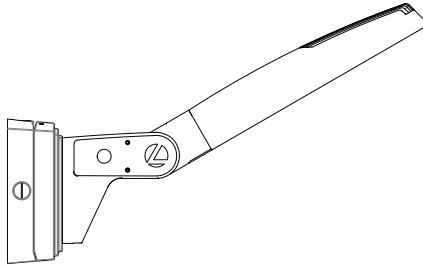

Surface Conduit Box (SCB) Mounting Detail

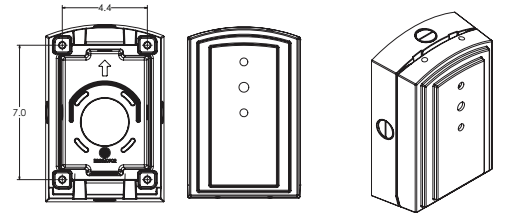

Length: 28.8" (73.2 cm)
 Width: 13.3" (33.8 cm)
 Height: 3.0" (7.6 cm) Main Body
 9.2" (23.4 cm) Arm

Automotive Front Row - Rotated Optics (AFRR90/R90)

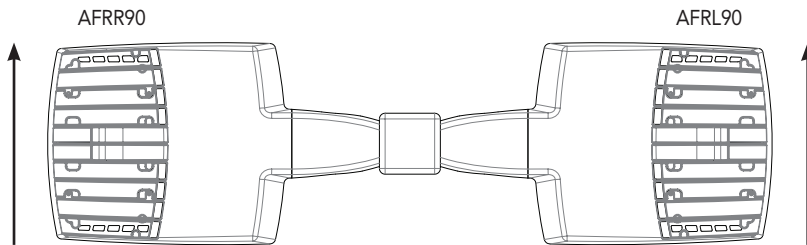

(Example: 2@180 - arrows indicate direction of light exiting the luminaire)

nLight Control - Sensor Coverage and Settings

nLight Sensor Coverage Pattern

NLTAIR2 PIRHN

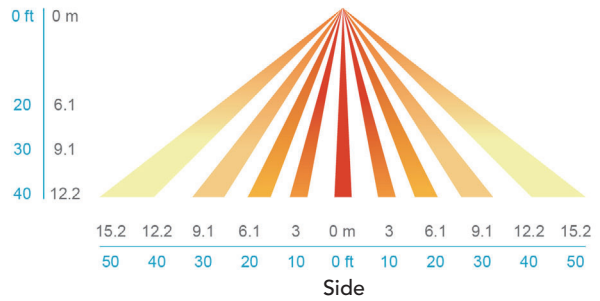
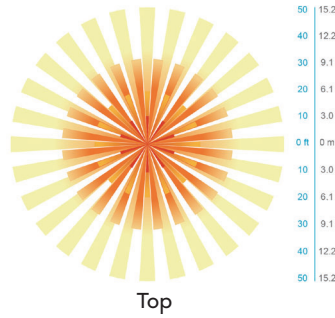
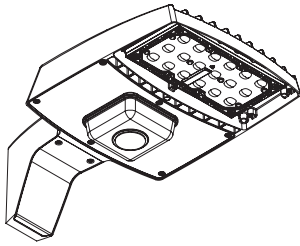

Motion Sensor Default Settings - Option PIRHN						
Option	Dimmed State (unoccupied)	High Level (when occupied)	Photocell Operation	Dwell Time (occupancy time delay)	Ramp-up Time (from unoccupied to occupied)	Ramp-down Time (from occupied to unoccupied)
NLTAIR2 PIRHN	Approx. 30% Output	100% Output	Enabled @ 1.5FC	7.5 minutes	3 seconds	5 minutes

*Note: NLTAIR2 PIRHN default settings including photocell set-point, high/low dim rates, and occupancy sensor time delay are all configurable using the Clarity Pro App. Sensor coverage pattern shown with luminaire at 0°. Sensor coverage pattern is affected when luminaire is tilted.

FEATURES & SPECIFICATIONS

INTENDED USE

The RSX LED area family is designed to provide a long-lasting, energy-efficient solution for the one-for-one replacement of existing metal halide or high pressure sodium lighting. The RSX1 delivers 7,000 to 17,000 lumens and is ideal for replacing 70W to 400W HID pole-mounted luminaires in parking lots and other area lighting applications.

CONSTRUCTION

The RSX LED area luminaire features a rugged die-cast aluminum main body that uses heat-dissipating fins and flow-through venting to provide optimal thermal management that both enhances LED performance and extends component life. Integral "no drill" mounting arm allows the luminaire to be mounted on existing pole drillings, greatly reducing installation labor. The light engines and housing are sealed against moisture and environmental contaminants to IP66. The low-profile design results in a low EPA, allowing pole optimization. All mountings are rated for minimum 1.5 G vibration load per ANSI C136.31. 3G Mountings: Include SPA, RPA, MA, IS, AASP, and AARP rated for 3G vibration. 1.5G Mountings: Include WBA, WBASC, AAWB and AAWSC rated for 1.5G vibration.

FINISH

Exterior parts are protected by a zinc-infused Super Durable TGIC thermoset powder coat finish that provides superior resistance to corrosion and weathering. A tightly controlled multi-stage process ensures superior adhesion as well as a minimum finish thickness of 3 mils. The result is a high-quality finish that is warranted not to crack or peel.

COASTAL CONSTRUCTION (CCE)

Optional corrosion resistant construction is engineered with added corrosion protection in materials and/or pre-treatment of base material under superDurable paint. Provides additional corrosion protection for applications near coastal areas. Finish is salt spray tested to over 5,000 hours per ASTM B117 with cribe rating of 10. Additional lead-times apply.

OPTICS

Precision acrylic refractive lenses are engineered for superior application efficiency, distributing the light to where it is needed most. Available in short and wide pattern distributions including Type 2, Type 3, Type 3S, Type 4, Type 4S, Type 5, Type 5S, AFR (Automotive Front Row), and AFR rotated AFR90 and ARFL90.

ELECTRICAL

Light engine(s) configurations consist of high-efficacy LEDs mounted on metal-core circuit boards and aluminum heat sinks to maximize heat dissipation. Light engines are IP66 rated. LED lumen maintenance is >L92/100,000 hours. CCT's of 3000K, 4000K and 5000K (minimum 70 CRI) are available. Fixtures ship standard with 0-10v dimming driver. Class 1 electronic drivers ensure system power factor >90% and THD <20%. Easily serviceable 10kV surge protection device meets a minimum Category C Low operation (per ANSI/IEEE C62.41.2).

STANDARD CONTROLS

The RSX LED area luminaire has a wide assortment of control options. Dusk to dawn controls include MVOLT and 347V button-type photocells and NEMA twist-lock photocell receptacles.

nLIGHT AIR CONTROLS

The RSX LED area luminaire is also available with nLight® AIR for the ultimate in wireless control. This powerful controls platform provides out-of-the-box basic motion sensing with photocontrol functionality and is suitable for mounting heights up to 40 feet. No commissioning is required when using factory default settings that provide basic stand-alone motion occupancy dimming that is switched on and off with a built-in photocell. See chart above for motion sensor default out-of-box settings. For more advanced wireless functionality, such as group dimming, nLight AIR can be commissioned using a smartphone and the easy-to-use CLAIRITY app. nLight AIR equipped luminaires can be grouped, resulting in motion sensor and photocell group response without the need for additional equipment. Scheduled dimming with motion sensor over-ride can be achieved when used with the nLight Eclipse. Additional information about nLight Air can be found [here](#).

INSTALLATION

Integral "no-drill" mounting arm allows for fast, easy mounting using existing pole drillings. Select the "SPA" option for square poles and the "RPA" option to mount to round poles. Note, the RPA mount can also be used for mounting to square poles by omitting the RPA adapter plate. Select the "MA" option to attach the luminaire to a 2 3/8" horizontal mast arm or the "IS" option for an adjustable slipfitter that mounts on a 2 3/8" OD tenon. The adjustable slipfitter has an integral junction box and offers easy installation. Can be tilted up to 90° above horizontal. Additional mountings are available including a wall bracket, adjustable tilt arm for direct-to-pole and wall and a surface conduit box for wall mount applications.

LISTINGS

CSA Certified to meet U.S. and Canadian standards. Suitable for wet locations. Rated for -40°C minimum ambient. DesignLights Consortium® (DLC) Premium qualified product and DLC qualified product. Not all versions of this product may be DLC Premium qualified or DLC qualified. Please check the DLC Qualified Products List at www.designlights.org/QPL to confirm which versions are qualified. International Dark-Sky Association (IDA) Fixture Seal of Approval (FSA) is available for all products on this page utilizing 3000K color temperature only. U.S. Patent No. D882, 146S

BUY AMERICAN ACT

Product with the BAA option is assembled in the USA and meets the Buy America(n) government procurement requirements under FAR, DFARS and DOT regulations. Please refer to www.acuitybrands.com/buy-american for additional information.

WARRANTY

5-year limited warranty. This is the only warranty provided and no other statements in this specification sheet create any warranty of any kind. All other express and implied warranties are disclaimed. Complete warranty terms located at: www.acuitybrands.com/support/warranty/terms-and-conditions

Note: Actual performance may differ as a result of end-user environment and application. All values are design or typical values, measured under laboratory conditions at 25 °C. Specifications subject to change without notice.





RSX1 LED Area Luminaire



Catalog Number
Notes
Type

Hit the Tab key or mouse over the page to see all interactive elements.

Specifications

EPA (ft ² @0°):	0.57 ft ² (0.05 m ²)
Length:	21.8" (55.4 cm) (SPA mount)
Width:	13.3" (33.8 cm)
Height:	3.0" (7.6 cm) Main Body 7.2" (18.4 cm) Arm
Weight: (SPA mount):	22.0 lbs (10.0 kg)

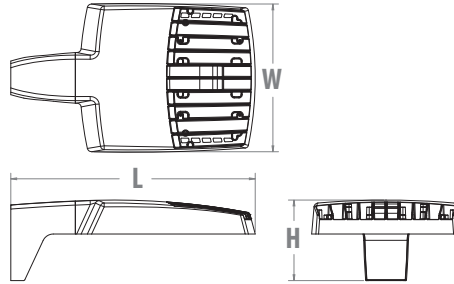

Introduction

The new RSX LED Area family delivers maximum value by providing significant energy savings, long life and outstanding photometric performance at an affordable price. The RSX1 delivers 7,000 to 17,000 lumens allowing it to replace 70W to 400W HID luminaires.

The RSX features an integral universal mounting mechanism that allows the luminaire to be mounted on most existing drill hole patterns. This "no-drill" solution provides significant labor savings. An easy-access door on the bottom of mounting arm allows for wiring without opening the electrical compartment. A mast arm adaptor, adjustable integral slipfitter and other mounting configurations are available.

ds Design Select options indicated by this color background.



Items marked by a shaded background qualify for the Design Select program and ship in 15 days or less. To learn more about Design Select, visit www.acuitybrands.com/designselect. *See ordering tree for details

Ordering Information

EXAMPLE: RSX1 LED P4 40K R3 MVOLT SPA DDBXD

RSX1 LED						
Series	Performance Package	Color Temperature	Distribution	Voltage	Mounting	
RSX1 LED	P1	30K 3000K	R2 Type 2 Wide	MVOLT (120V-277V) ²	SPA Square pole mounting (3.0" min. SQ pole for 1 at 90°, 3.5" min. SQ pole for 2, 3, 4 at 90°) RPA Round pole mounting (3.2" min. dia. RND pole for 2, 3, 4 at 90°, 3.0" min. dia. RND pole for 1 at 90°, 2 at 180°, 3 at 120°) MA Mast arm adaptor (fits 2-3/8" OD horizontal tenon) IS Adjustable slipfitter (fits 2-3/8" OD tenon) ⁶ WBA Wall bracket ¹ WBASC Wall bracket with surface conduit box AASP Adjustable tilt arm square pole mounting ⁶ AARP Adjustable tilt arm round pole mounting ⁶ AAWB Adjustable tilt arm with wall bracket ⁶ AAWSC Adjustable tilt arm wall bracket and surface conduit box ⁶	
	P2	40K 4000K	R3 Type 3 Wide	HVOLT (347V-480V) ³		
	P3	50K 5000K	R3S Type 3 Short	XVOLT (277V-480V) ⁴		
	P4	R4 Type 4 Wide	(use specific voltage for options as noted)			
		R4S Type 4 Short				
		R5 Type 5 Wide ¹				120 ³ 277 ⁵
		R5S Type 5 Short ¹				208 ³ 347 ⁵
		AFR Automotive Front Row				240 ³ 480 ⁵
		AFRR90 Automotive Front Row Right Rotated				
	AFRL90 Automotive Front Row Left Rotated					

Options	Finish
Shipped Installed HS House-side shield ⁷ PE Photocontrol, button style ^{8,9} PER7 Seven-wire twist-lock receptacle only (no controls) ^{9,10,11} SF Single fuse (120, 277, 347) ⁵ DF Double fuse (208, 240, 480) ⁵ SPD20KV 20KV Surge pack (10KV standard) FAO Field adjustable output ⁹ DMG 0-10V dimming extend out back of housing for external control (control ordered separate) ⁹	DDBXD Dark Bronze DBLXD Black DNAXD Natural Aluminum DWHXD White DDBTXD Textured Dark Bronze DBLTXD Textured Black DNATXD Textured Natural Aluminum DWHGXD Textured White
Shipped Separately (requires some field assembly) EGS External glare shield ⁷ EGFV External glare full visor (360° around light aperture) ⁷ BS Bird spikes ¹⁶	



Ordering Information

Accessories

Ordered and shipped separately.

RSX1HS	RSX1 House side shield (includes 1 shield)
RSX1HSAFRU	RSX1 House side shield for AFR rotated optics (includes 1 shield)
RSX1EGS (FINISH) U	External glare shield (specify finish)
RSX1EGFV (FINISH) U	External glare full visor (specify finish)
RSXRPA (FINISH) U	RSX Universal round pole adaptor plate (specify finish)
RSXWBA (FINISH) U	RSX WBA wall bracket (specify finish) ¹
RSXSCB (FINISH) U	RSX Surface conduit box (specify finish, for use with WBA, WBA not included)
DLL127F 1.5 JU	Photocell -SSL twist-lock (120-277V) ¹⁷
DLL347F 1.5 CUL JU	Photocell -SSL twist-lock (347V) ¹⁷
DLL480F 1.5 CUL JU	Photocell -SSL twist-lock (480V) ¹⁷
DSHORT SBK U	Shorting cap ¹⁷

NOTES

- Any Type 5 distribution, is not available with WBA.
- MVOLT driver operates on any line voltage from 120-277V (50/60 Hz).
- HVOLT driver operates on any line voltage from 347-480V (50/60 Hz).
- XVOLT driver not available with P1 or P2. XVOLT driver operates on any line voltage from 277V-480V (50/60 Hz). XVOLT not available with fusing (SF or DF) and not available with PE.
- Single fuse (SF) requires 120V, 277V or 347V. Double fuse (DF) requires 208V, 240V or 480V.
- Maximum tilt is 90° above horizontal.
- It may be ordered as an accessory.
- Requires MVOLT or 347V.
- Two or more of the following options cannot be combined including PE, DMG, PER7, FAO and NLTAIR2 PIRHN. (Exception: PE and FAO can be combined; also PE and DMG can be combined.)
- Compatible with standard twist-lock photocells for dusk to dawn operation or advanced control nodes that provide 0-10V dimming

- signals. Wire 4/Wire 5 wired to dimming leads on driver. Wire6/Wire7 capped inside luminaire. Twistlock photocell ordered and shipped as a separate line item from Acuity Brands Controls. See accessories. Shorting Cap included.
- For units with option PER7, the mounting must be restricted to +/- 45° from horizontal aim per ANSI C136.10-2010.
 - Must be ordered with PIRHN.
 - Requires MVOLT or HVOLT.
 - Must be ordered with NLTAIR2. For additional information on PIRHN visit [here](#).
 - CCE option not available with WBA, WBASC, AASP, AARP, AAWB, AAWBSC, EGS, EGFV and BS.
 - Must be ordered with fixture for factory pre-drilling.
 - Requires luminaire to be specified with PER7 option. Ordered and shipped as a separate line item from Acuity Brands Controls.

External Shields

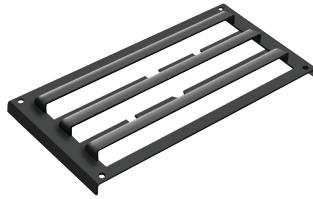

House Side Shield



External Glare Shield



External 360 Full Visor

Pole/Mounting Information

Accessories including bullhorns, cross arms and other adapters are available under the accessories tab at Lithonia's Outdoor Poles and Arms product page. Click here to visit [Accessories](#).

HANDHOLE ORIENTATION

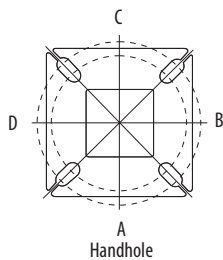

RSX POLE DRILLING

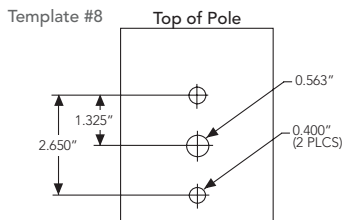

RSX STANDARD ARM & ADJUSTABLE ARM

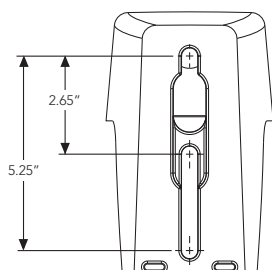

Round Tenon Mount - Pole Top Slipfitters

Tenon O.D.	RSX Mounting	Single	2 @ 180°	2 @ 90°	3 @ 120°	3 @ 90°	4 @ 90°
2 - 3/8"	RPA, AARP	AS3-5 190	AS3-5 280	AS3-5 290	AS3-5 320	AS3-5 390	AS3-5 490
2 - 7/8"	RPA, AARP	AST25-190	AST25-280	AST25-290	AST25-320	AST25-390	AST25-490
4"	RPA, AARP	AST35-190	AST35-280	AST35-290	AST35-320	AST35-390	AST35-490

Drill/Side Location by Configuration Type

Drilling Template	Mounting Option	Single	2 @ 180	2 @ 90	3 @ 120	3 @ 90	4 @ 90
#8	Head Location	Side B	Side B & D	Side B & C	Round Pole Only	Side B, C & D	Side A, B, C & D
#8	Drill Nomenclature	DM19AS	DM28AS	DM29AS	DM32AS	DM39AS	DM49AS

RSX1 - Luminaire EPA

*Includes luminaire and integral mounting arm. Other tenons, arms, brackets or other accessories are not included in this EPA data.

Fixture Quantity & Mounting Configuration	Single	2 @ 90	2 @ 180	3 @ 90	3 @ 120	4 @ 90	2 Side by Side	3 Side by Side	4 Side by Side	
SPA - Square Pole Adaptor	0.57	1.03	1.05	1.52	1.36	2.03	1.31	1.7	2.26	
RPA - Round Pole Adaptor	0.62	1.08	1.15	1.62	1.46	2.13	1.36	1.8	2.36	
MA - Mast Arm Adaptor	0.49	0.95	0.89	1.36	1.2	1.87	1.23	1.54	2.1	
IS - Integral Slipfitter AASP/AARP - Adjustable Arm Square/Round Pole	0°	0.57	1.03	1.05	1.52	1.36	2.03	1.31	1.7	2.26
	10°	0.68	1.34	1.33	2	1.74	2.64	1.35	2.03	2.71
	20°	0.87	1.71	1.73	2.56	2.26	3.42	1.75	2.62	3.49
	30°	1.24	2.19	2.3	3.21	2.87	4.36	2.49	3.73	4.97
	40°	1.81	2.68	2.98	3.85	3.68	5.30	3.62	5.43	7.24
	45°	2.11	2.92	3.44	4.2	4.08	5.77	4.22	6.33	8.44
	50°	2.31	3.17	3.72	4.52	4.44	6.26	4.62	6.94	9.25
	60°	2.71	3.66	4.38	5.21	5.15	7.24	5.43	8.14	10.86
	70°	2.78	3.98	4.54	5.67	5.47	7.91	5.52	8.27	11.03
	80°	2.76	4.18	4.62	5.97	5.76	8.31	5.51	8.27	11.03
90°	2.73	4.25	4.64	6.11	5.91	8.47	5.45	8.18	10.97	

Isofootcandle plots for the RSX1 LED P4 40K. Distances are in units of mounting height (20').

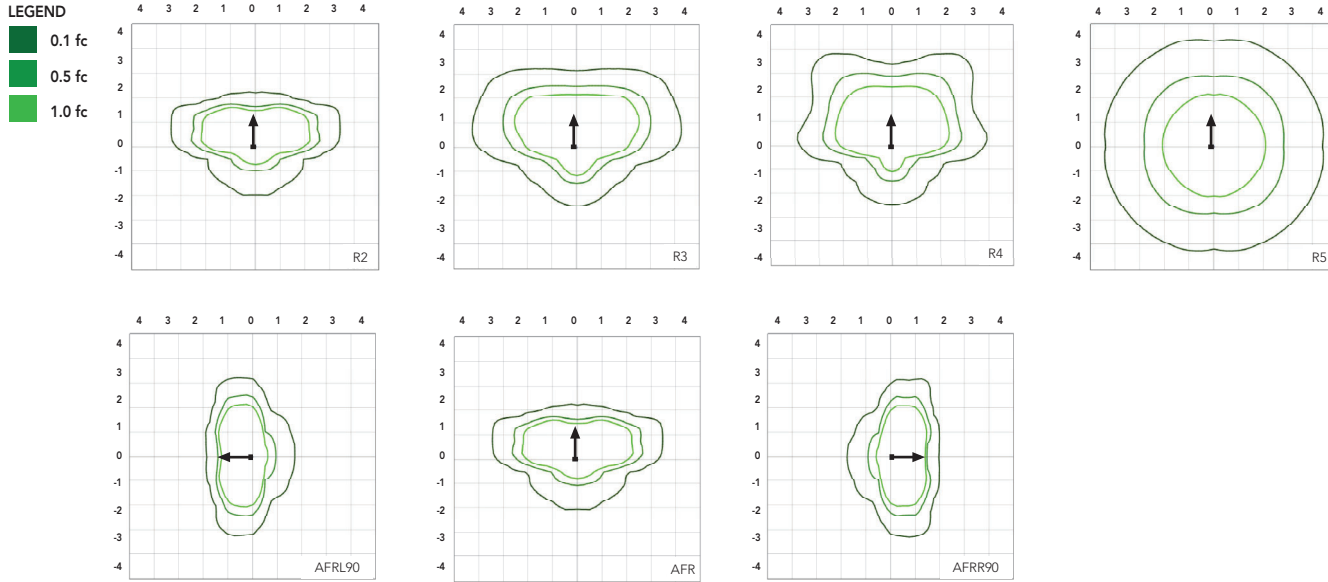

Performance Data

Lumen Ambient Temperature (LAT) Multipliers

Use these factors to determine relative lumen output for average ambient temperatures from 0-50°C (32-122°F).

Ambient	Ambient	Lumen Multiplier
0°C	32°F	1.05
5°C	41°F	1.04
10°C	50°F	1.03
15°C	59°F	1.02
20°C	68°F	1.01
25°C	77°F	1.00
30°C	86°F	0.99
35°C	95°F	0.98
40°C	104°F	0.97
45°C	113°F	0.96
50°C	122°F	0.95

Electrical Load

Performance Package	System Watts (W)	Current (A)					
		120V	208V	240V	277V	347V	480V
P1	51W	0.42	0.25	0.21	0.19	0.14	0.11
P2	72W	0.60	0.35	0.30	0.26	0.21	0.15
P3	109W	0.91	0.52	0.45	0.39	0.31	0.23
P4	133W	1.11	0.64	0.55	0.48	0.38	0.27

Projected LED Lumen Maintenance

Operating Hours	50,000	75,000	100,000
Lumen Maintenance Factor	>0.97	>0.95	>0.92

Values calculated according to IESNA TM-21-11 methodology and valid up to 40°C.

Lumen Output

Lumen values are from photometric tests performed in accordance with IESNA LM-79-08. Data is considered to be representative of the configurations shown, within the tolerances allowed by Lighting Facts. Contact factory for performance data on any configurations not shown here.

Performance Package	System Watts	Distribution Type	30K (3000K, 70 CRI)					40K (4000K, 70 CRI)					50K (5000K, 70 CRI)				
			Lumens	B	U	G	LPW	Lumens	B	U	G	LPW	Lumens	B	U	G	LPW
P1	51W	R2	6,482	1	0	1	126	7,121	1	0	1	139	7,121	1	0	1	139
		R3	6,459	1	0	2	127	7,096	1	0	2	139	7,096	1	0	2	139
		R35	6,631	1	0	1	129	7,286	1	0	2	142	7,286	1	0	2	142
		R4	6,543	1	0	2	128	7,189	1	0	2	141	7,189	1	0	2	141
		R45	6,313	1	0	1	124	6,936	1	0	1	136	6,936	1	0	1	136
		R5	6,631	3	0	2	130	7,286	3	0	2	143	7,286	3	0	2	143
		R55	6,807	3	0	1	133	7,479	3	0	1	147	7,479	3	0	1	147
		AFR	6,473	1	0	1	127	7,112	1	0	1	139	7,112	1	0	1	139
		AFRR90	6,535	2	0	2	127	7,179	2	0	2	140	7,179	2	0	2	140
AFRL90	6,562	2	0	1	128	7,210	2	0	2	140	7,210	2	0	2	140		
P2	72W	R2	8,991	2	0	1	123	9,878	2	0	1	135	9,878	2	0	1	135
		R3	8,959	2	0	2	124	9,843	2	0	2	137	9,843	2	0	2	137
		R35	9,198	2	0	2	126	10,106	2	0	2	139	10,106	2	0	2	139
		R4	9,077	2	0	2	126	9,972	2	0	2	139	9,972	2	0	2	139
		R45	8,757	1	0	2	122	9,622	2	0	2	134	9,622	2	0	2	134
		R5	9,198	4	0	2	128	10,106	4	0	2	140	10,106	4	0	2	140
		R55	9,443	3	0	1	131	10,374	3	0	1	144	10,374	3	0	1	144
		AFR	8,979	2	0	1	125	9,865	2	0	1	137	9,865	2	0	1	137
		AFRR90	9,064	3	0	2	124	9,959	3	0	2	137	9,959	3	0	2	137
AFRL90	9,102	3	0	2	125	10,001	3	0	2	137	10,001	3	0	2	137		
P3	109W	R2	12,808	2	0	1	117	14,072	2	0	2	129	14,072	2	0	2	129
		R3	12,763	2	0	2	117	14,023	2	0	2	129	14,023	2	0	2	129
		R35	13,104	2	0	2	120	14,397	2	0	2	132	14,397	2	0	2	132
		R4	12,930	2	0	2	119	14,206	2	0	2	130	14,206	2	0	2	130
		R45	12,475	2	0	2	114	13,707	2	0	2	126	13,707	2	0	2	126
		R5	13,104	4	0	2	120	14,397	4	0	2	132	14,397	4	0	2	132
		R55	13,452	3	0	2	123	14,779	3	0	2	136	14,779	3	0	2	136
		AFR	12,791	2	0	1	117	14,053	2	0	2	129	14,053	2	0	2	129
		AFRR90	12,913	3	0	3	118	14,187	3	0	3	130	14,187	3	0	3	130
AFRL90	12,967	3	0	2	118	14,247	3	0	3	130	14,247	3	0	3	130		
P4	133W	R2	14,943	2	0	2	112	16,417	2	0	2	123	16,417	2	0	2	123
		R3	14,890	2	0	3	112	16,360	2	0	3	123	16,360	2	0	3	123
		R35	15,287	2	0	2	115	16,796	2	0	2	126	16,796	2	0	2	126
		R4	15,085	2	0	3	113	16,574	2	0	3	125	16,574	2	0	3	125
		R45	14,554	2	0	2	109	15,991	2	0	2	120	15,991	2	0	2	120
		R5	15,287	4	0	2	115	16,796	4	0	2	126	16,796	4	0	2	126
		R55	15,693	4	0	2	118	17,242	4	0	2	130	17,242	4	0	2	130
		AFR	14,923	2	0	2	112	16,395	2	0	2	123	16,395	2	0	2	123
		AFRR90	15,065	3	0	3	113	16,551	3	0	3	124	16,551	3	0	3	124
AFRL90	15,128	3	0	3	114	16,621	3	0	3	125	16,621	3	0	3	125		

Dimensions & Weights

Luminaire Weight by Mounting Type

Mounting Configuration	Total Luminaire Weight
SPA	22 lbs
RPA	24 lbs
MA	22 lbs
WBA	25 lbs
WBASC	28 lbs
IS	25 lbs
AASP	25 lbs
AARP	27 lbs
AAWB	28 lbs
AAWSC	31 lbs

RSX1 with Round Pole Adapter (RPA)

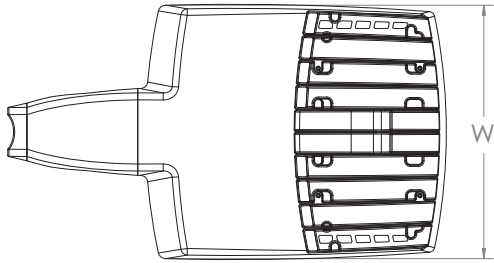

Length: 22.8" (57.9 cm)
 Width: 13.3" (33.8 cm)
 Height: 3.0" (7.6 cm) Main Body
 7.2" (18.4 cm) Arm

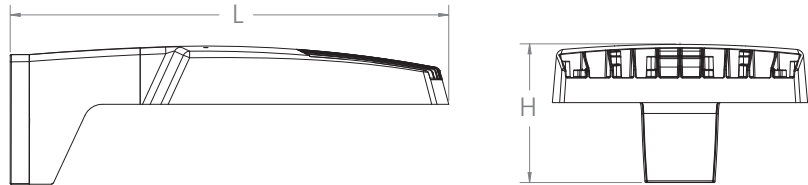

Note: RPA — Round Pole mount can also be used to mount on square poles by omitting the round pole adapter plate shown here.



RSX1 with Mast Arm Adapter (MA)

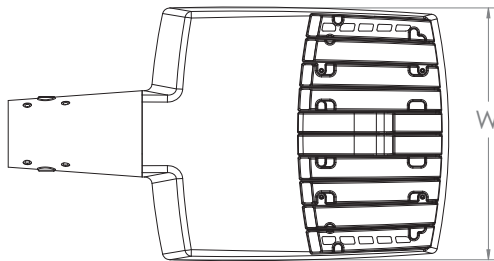

Length: 23.2" (59.1 cm)
 Width: 13.3" (33.8 cm)
 Height: 3.0" (7.6 cm) Main Body
 3.5" (8.9 cm) Arm

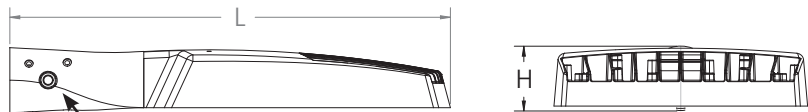

7/16" locking thru bolt/nut provided

RSX1 with Adjustable Slipfitter (IS)

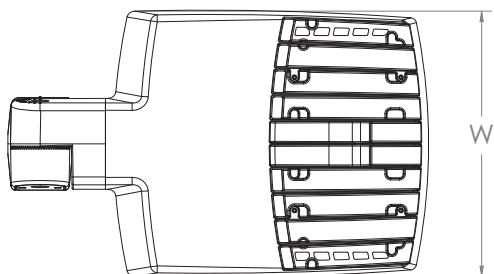

Length: 20.7" (52.7 cm)
 Width: 13.3" (33.8 cm)
 Height: 3.0" (7.6 cm) Main Body
 7.6" (19.3 cm) Arm

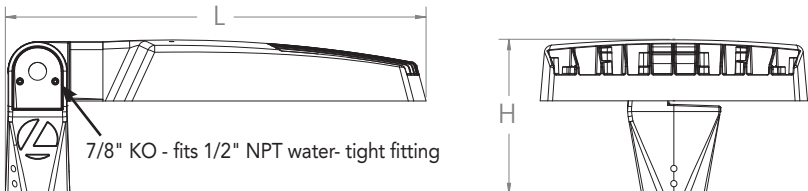

7/8" KO - fits 1/2" NPT water-tight fitting

Dimensions

RSX1 with Wall Bracket (WBA)

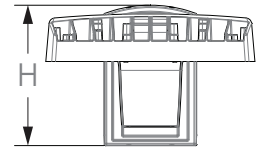
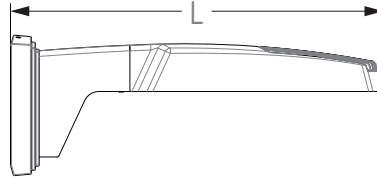
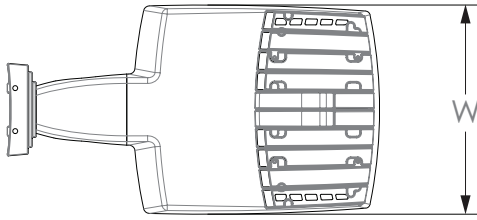

Length: 23.6" (59.9 cm)
 Width: 13.3" (33.8 cm)
 Height: 3.0" (7.6 cm) Main Body
 8.9" (22.6 cm) Arm

Wall Bracket (WBA) Mounting Detail

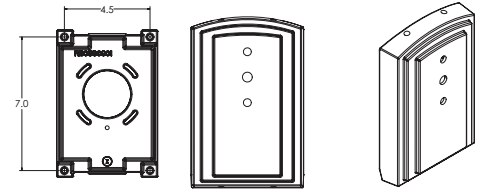

RSX1 with Wall Bracket with Surface Conduit Box (WBASC)

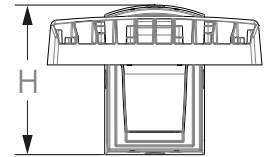
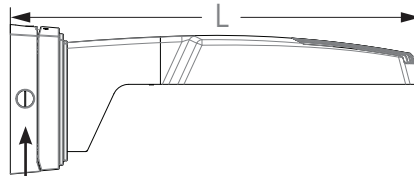
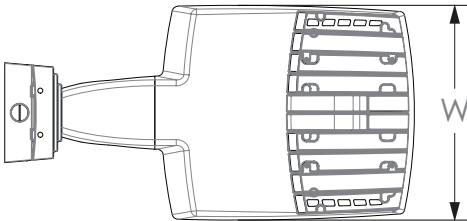

3/4" NPT taps with plugs - Qty (4) provided

Length: 25.3" (64.3 cm)
 Width: 13.3" (33.8 cm)
 Height: 3.0" (7.6 cm) Main Body
 9.2" (23.4 cm) Arm

Surface Conduit Box (SCB) Mounting Detail

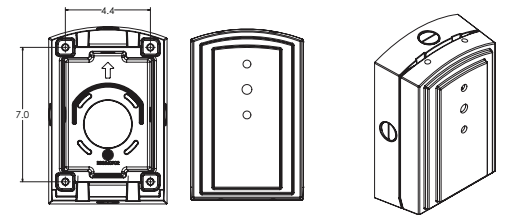

Dimensions

RSX1 with Adjustable Tilt Arm - Square or Round Pole (AASP or AARP)

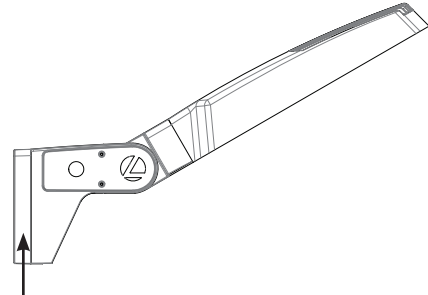
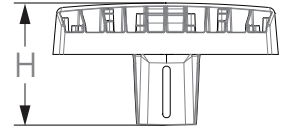
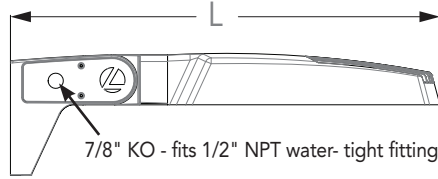
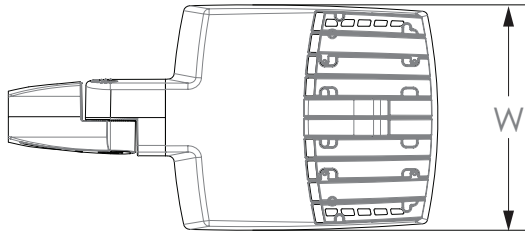

NOTE:
RPA - Round Pole mount can also be used to mount on square poles by omitting the round pole adapter plate shown here.



Length: 25.3" (65.3 cm) **AASP**
26.3" (66.8 cm) **AARP**
Width: 13.3" (33.8 cm)
Height: 3.0" (7.6 cm) Main Body
7.2" (18.2 cm) Arm

Notes

AASP: Requires 3.0" min. square pole for 1 at 90°. Requires 3.5" min. square pole for mounting 2, 3, 4 at 90°.

AARP: Requires 3.2" min. dia. round pole for 2, 3, 4 at 90°. Requires 3.0" min. dia. round pole for mounting 1 at 90°, 2 at 180°, 3 at 120°.

RSX1 with Adjustable Tilt Arm with Wall Bracket (AAWB)

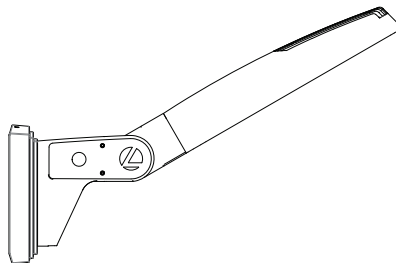
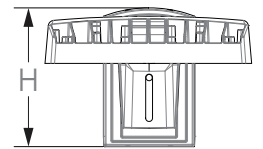
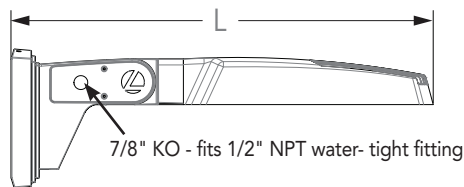
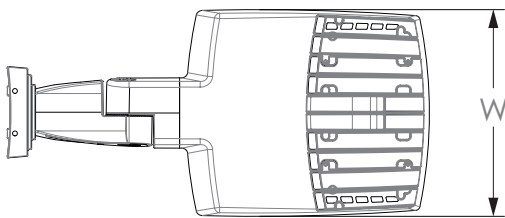

Wall Bracket (WBA) Mounting Detail

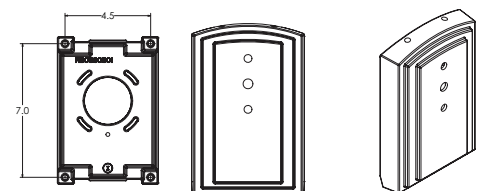

Length: 27.1" (68.8 cm)
Width: 13.3" (33.8 cm)
Height: 3.0" (7.6 cm) Main Body
8.9" (22.6 cm) Arm

Dimensions

RSX1 with Adjustable Tilt Arm with Wall Bracket and Surface Conduit Box (AAWSC)

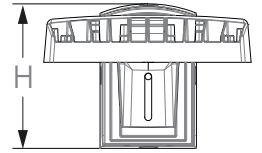
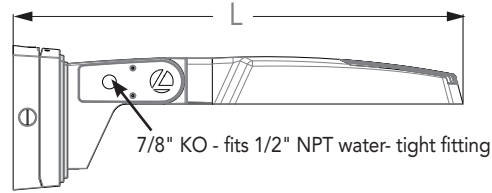
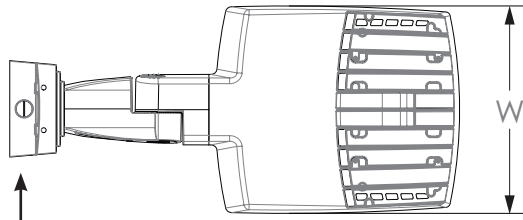

3/4" NPT taps with plugs - Qty (4) provided

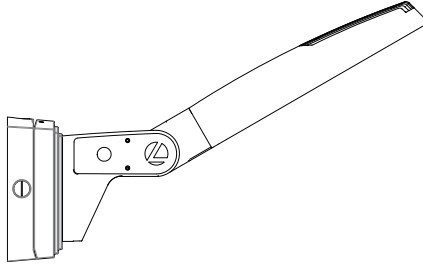

Length: 28.8" (73.2 cm)
 Width: 13.3" (33.8 cm)
 Height: 3.0" (7.6 cm) Main Body
 9.2" (23.4 cm) Arm

Surface Conduit Box (SCB) Mounting Detail

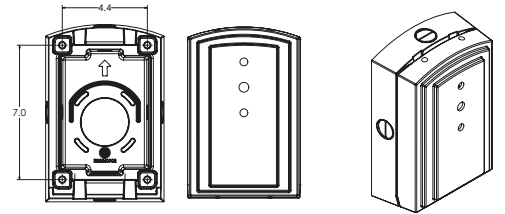

Automotive Front Row - Rotated Optics (AFRR90/R90)

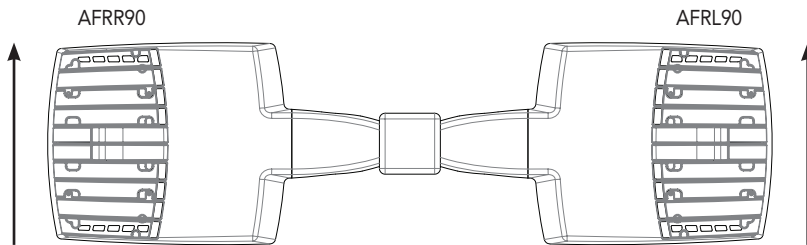

(Example: 2@180 - arrows indicate direction of light exiting the luminaire)

nLight Control - Sensor Coverage and Settings

nLight Sensor Coverage Pattern

NLTAIR2 PIRHN

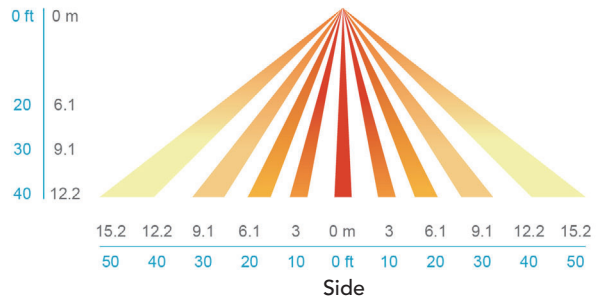
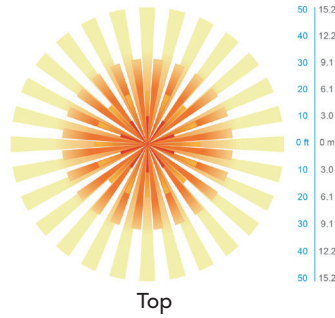
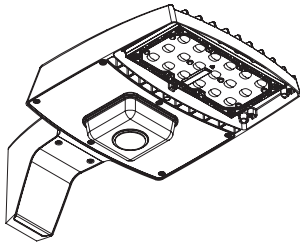

Motion Sensor Default Settings - Option PIRHN						
Option	Dimmed State (unoccupied)	High Level (when occupied)	Photocell Operation	Dwell Time (occupancy time delay)	Ramp-up Time (from unoccupied to occupied)	Ramp-down Time (from occupied to unoccupied)
NLTAIR2 PIRHN	Approx. 30% Output	100% Output	Enabled @ 1.5FC	7.5 minutes	3 seconds	5 minutes

*Note: NLTAIR2 PIRHN default settings including photocell set-point, high/low dim rates, and occupancy sensor time delay are all configurable using the Clarity Pro App. Sensor coverage pattern shown with luminaire at 0°. Sensor coverage pattern is affected when luminaire is tilted.

FEATURES & SPECIFICATIONS

INTENDED USE

The RSX LED area family is designed to provide a long-lasting, energy-efficient solution for the one-for-one replacement of existing metal halide or high pressure sodium lighting. The RSX1 delivers 7,000 to 17,000 lumens and is ideal for replacing 70W to 400W HID pole-mounted luminaires in parking lots and other area lighting applications.

CONSTRUCTION

The RSX LED area luminaire features a rugged die-cast aluminum main body that uses heat-dissipating fins and flow-through venting to provide optimal thermal management that both enhances LED performance and extends component life. Integral "no drill" mounting arm allows the luminaire to be mounted on existing pole drillings, greatly reducing installation labor. The light engines and housing are sealed against moisture and environmental contaminants to IP66. The low-profile design results in a low EPA, allowing pole optimization. All mountings are rated for minimum 1.5 G vibration load per ANSI C136.31. 3G Mountings: Include SPA, RPA, MA, IS, AASP, and AARP rated for 3G vibration. 1.5G Mountings: Include WBA, WBASC, AAWB and AAWSC rated for 1.5G vibration.

FINISH

Exterior parts are protected by a zinc-infused Super Durable TGIC thermoset powder coat finish that provides superior resistance to corrosion and weathering. A tightly controlled multi-stage process ensures superior adhesion as well as a minimum finish thickness of 3 mils. The result is a high-quality finish that is warranted not to crack or peel.

COASTAL CONSTRUCTION (CCE)

Optional corrosion resistant construction is engineered with added corrosion protection in materials and/or pre-treatment of base material under superDurable paint. Provides additional corrosion protection for applications near coastal areas. Finish is salt spray tested to over 5,000 hours per ASTM B117 with cribe rating of 10. Additional lead-times apply.

OPTICS

Precision acrylic refractive lenses are engineered for superior application efficiency, distributing the light to where it is needed most. Available in short and wide pattern distributions including Type 2, Type 3, Type 3S, Type 4, Type 4S, Type 5, Type 5S, AFR (Automotive Front Row), and AFR rotated AFR90 and ARFL90.

ELECTRICAL

Light engine(s) configurations consist of high-efficacy LEDs mounted on metal-core circuit boards and aluminum heat sinks to maximize heat dissipation. Light engines are IP66 rated. LED lumen maintenance is >L92/100,000 hours. CCT's of 3000K, 4000K and 5000K (minimum 70 CRI) are available. Fixtures ship standard with 0-10v dimming driver. Class 1 electronic drivers ensure system power factor >90% and THD <20%. Easily serviceable 10kV surge protection device meets a minimum Category C Low operation (per ANSI/IEEE C62.41.2).

STANDARD CONTROLS

The RSX LED area luminaire has a wide assortment of control options. Dusk to dawn controls include MVOLT and 347V button-type photocells and NEMA twist-lock photocell receptacles.

nLIGHT AIR CONTROLS

The RSX LED area luminaire is also available with nLight® AIR for the ultimate in wireless control. This powerful controls platform provides out-of-the-box basic motion sensing with photocontrol functionality and is suitable for mounting heights up to 40 feet. No commissioning is required when using factory default settings that provide basic stand-alone motion occupancy dimming that is switched on and off with a built-in photocell. See chart above for motion sensor default out-of-box settings. For more advanced wireless functionality, such as group dimming, nLight AIR can be commissioned using a smartphone and the easy-to-use CLAIRITY app. nLight AIR equipped luminaires can be grouped, resulting in motion sensor and photocell group response without the need for additional equipment. Scheduled dimming with motion sensor over-ride can be achieved when used with the nLight Eclipse. Additional information about nLight Air can be found [here](#).

INSTALLATION

Integral "no-drill" mounting arm allows for fast, easy mounting using existing pole drillings. Select the "SPA" option for square poles and the "RPA" option to mount to round poles. Note, the RPA mount can also be used for mounting to square poles by omitting the RPA adapter plate. Select the "MA" option to attach the luminaire to a 2 3/8" horizontal mast arm or the "IS" option for an adjustable slipfitter that mounts on a 2 3/8" OD tenon. The adjustable slipfitter has an integral junction box and offers easy installation. Can be tilted up to 90° above horizontal. Additional mountings are available including a wall bracket, adjustable tilt arm for direct-to-pole and wall and a surface conduit box for wall mount applications.

LISTINGS

CSA Certified to meet U.S. and Canadian standards. Suitable for wet locations. Rated for -40°C minimum ambient. DesignLights Consortium® (DLC) Premium qualified product and DLC qualified product. Not all versions of this product may be DLC Premium qualified or DLC qualified. Please check the DLC Qualified Products List at www.designlights.org/QPL to confirm which versions are qualified. International Dark-Sky Association (IDA) Fixture Seal of Approval (FSA) is available for all products on this page utilizing 3000K color temperature only. U.S. Patent No. D882, 146S

BUY AMERICAN ACT

Product with the BAA option is assembled in the USA and meets the Buy America(n) government procurement requirements under FAR, DFARS and DOT regulations. Please refer to www.acuitybrands.com/buy-american for additional information.

WARRANTY

5-year limited warranty. This is the only warranty provided and no other statements in this specification sheet create any warranty of any kind. All other express and implied warranties are disclaimed. Complete warranty terms located at: www.acuitybrands.com/support/warranty/terms-and-conditions

Note: Actual performance may differ as a result of end-user environment and application. All values are design or typical values, measured under laboratory conditions at 25 °C. Specifications subject to change without notice.

